

SHARP®**SERVICE MANUAL**

SEJB70GS64S00

Issued: 14th Dec 2001

DA-100 CHASSIS

PAL SYSTEM COLOUR TELEVISION

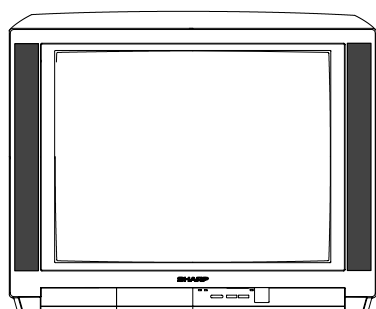
**MODEL 70GS-64S_{DE/IT}**

In the interests of user safety (required by safety regulations in some countries) the set should be restored to its original condition and only parts identical to those specified should be used.

CONTENTS

ELECTRICAL SPECIFICATION.....	3	SCHEMATIC DIAGRAM.....	21
IMPORTANT SERVICE NOTES.....	4	STEREO LED FLASHING CODE.....	29
ADJUSTMENTS PROCEDURES.....	5	BLOCK DIAGRAM.....	30
PRINTED WIRING BOARDS.....	10	PARTS LISTING.....	32
COMPONENT LOCATION TABLES.....	15	ALTERNATIVE PARTS.....	41

SHARP CORPORATION

This document has been published to be used for after sales service only.

ELECTRICAL SPECIFICATIONS

- Power Input 220V-240 Volts AC 50Hz
- Power Consumption
 - Normal Operation84W
 - Stand-by Operation1,3W
- Audio Power Output Rating (MPO) / Impedance
 - Internal Left Speaker 10W, 7 Ω
 - Internal Right Speaker 10W, 7 Ω
- Speakers
 - Left / Right 6,5 x 13cm
- White Level

Set brightness control to get total picture tube cathode current of 600 milliammeter under no signal condition. Maximum necessary correction of each picture tube cathode current to get 8550 degrees K-20 MPCD screen temperature should not exceed 15% of its original value.

X=0.290 Y=0.300
- Convergence
 - Static (Centre) .. between any two colours
 - Dynamic after static equals zero
- Focus High Bi-Potential Electrostatic
- Sweep Deflection Magnetic
- Picture Intermediate frequency 38.9MHz
- Sound Carrier Trap 33.4MHz
- Adjacent Sound Carrier Trap 40.4MHz
- Adjacent Picture Carrier Trap 31.9MHz
- Aerial Input Impedance
 - VHF/UHF 75 ohm Unbalanced
- Tuning Ranges 48.25 MHz thru 855.25 MHz
 - VHF: E2-E12 CH
 - S1-S41 CH (Hiperband)
 - UHF: E21-E69 CH

Specifications are subject to change without prior notice.

MODEL DESTINATION (Operation Manual languages).

70GS-64SDE: Dutch

70GS-64SIT: Italian.

WARNING

The chassis in this receiver is partially hot. Use an isolation transformer between the line cord plug and power receptacle, when servicing this chassis.

To prevent electric shock, do not remove cover. No user-serviceable parts inside. Refer servicing to qualified service personnel.

IMPORTANT SERVICING NOTES

Only qualified service personnel are allowed to carry out maintenance and repair of this receiver.

SERVICING OF HIGH VOLTAGE SYSTEM AND CRT

It is important that the static charge is removed from the high voltage system when carrying out work on the receiver. This can be achieved by connecting a 10K resistor (with a suitably insulated lead) from the CRT cavity connector to the CRT ground tag. This must be carried out with the AC supply disconnected from the receiver.

Note the following:

- The CRT in this receiver employs Integral Implosion Protection.
- If the CRT has to be changed it **MUST** be replaced with the correct type for continued safe working
- **DO NOT** lift the CRT by its neck.
- When handling the CRT, ensure that shatterproof goggles are worn.
- Ensure that the CRT is discharge before handling.

X-RAY

This receiver is designed to keep any x-ray emission to an absolute minimum. Some fault conditions and servicing procedures may produce potentially hazardous x-ray radiation levels. This is a problem when in close proximity to the receiver for long periods of time. To reduce any risks associated with this, please observe the following precautions:

1. When undertaking any servicing on this chassis, **DO NOT** increase the EHT to more than 28 KV, (at a instantaneous beam current of 1500 μ A).
2. Ensure that during normal operation the EHT does not exceed 25KV \pm 1.5KV (at a beam current of 1000 μ A). This level has been preset in the factory. Always check that this level has not been exceeded after carrying out any repair on the receiver.
3. **DO NOT** replace the CRT with any other type than that specified in the parts listing as this may cause excessive x-ray radiation.

BEFORE RETURNING THE RECEIVER TO THE CUSTOMER

In addition to the above checks, the following should also be carried out before returning the receiver to the customer.

1. Inspect all the leads to ensure that they are dressed correctly and that they are not obstructed or pinched by any other parts.
2. Ensure that all protective devices are in good condition. These will include nonmetallic control knobs, insulating fish papers, cabinets backs, compartment covers or shields, mechanical insulators, etc.

ADJUSTMENT PROCEDURES

All adjustments to this chassis, except for focus, are carried out in the service mode.

• SERVICE MODE

The service mode is provided to enable the engineer to correctly set up the receiver to the CRT fitted in the set. Note that these adjustments may vary from one receiver to another.

To enter the service mode, carry out the following procedure.

1. Connect a test pattern to the antenna terminal.
2. Tune the receiver to this signal.
3. Turn the receiver off using the mains switch.
4. Press volume down and channel up buttons on the front of the receiver at the same time.
5. Keeping these buttons pressed, turn the mains on.
6. When the set starts up it will be in service mode.
7. Release the two buttons.

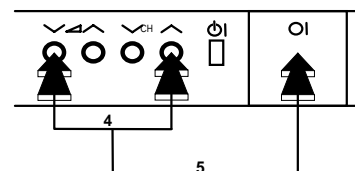

- Use the channel up and down buttons to move between the options.
- Use the volume control buttons to change the data.
- To store the data, use the stand-by button on the remote control.
- To exit the service mode, turn the receiver off using the mains switch.

When the service mode is entered the following On Screen Display appears

-SERVICE SOFTWARE AND HEXADECIMAL COUNTER DISPLAY:
SW ON XXXX SW OFF XXXX HOURS ON XXXX

The figures displayed in the XXXX locations are hexadecimal representations of the number of times that particular function has been executed. For example if the hexadecimal number displayed after SW ON was 0E4A, this would correspond to the receiver being turned on 3658 times.

Adjustment menu:

The following adjustments can be carried out in the service mode.

- | | |
|---------------------------|-------------------------------|
| • Horizontal Shift | • Green Cut Off |
| • East West Width | • Blue Cut Off |
| • Pin Phase | • Alter NVM Page |
| • Pin Amp | • Alter NVM Position |
| • Upper corner correction | • Alter NVM Value |
| • Lower corner correction | • Teletext Mix Mode Contrast |
| • Vertical Linearity | • Teletext Contrast |
| • Vertical angle | • OSD Contrast |
| • Vertical bow | • DVCO Adjustment (Only PAL) |
| • Vertical Amplitude | • DVCO Adjustment (Only NTSC) |
| • S Correction | • Luma chroma delay |
| • Vertical Shift | • AGC Adjustment |
| • Red Gain | • AFT Adjustment |
| • Green Gain | • OPC Value |
| • Blue Gain | • Auto Installation On/Off |
| • Red Cut Off | |

Geometry Adjustments

All geometry adjustments are based on an internally generated test pattern as shown in figure 1. When carrying out any of the above geometry adjustments, use the internally generated test pattern for guidance.

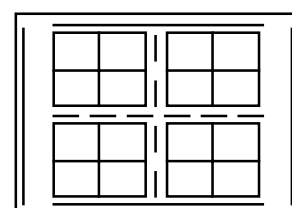

Fig.1

The following geometry adjustments can be carried out. Detailed instructions on how to execute these are given on the following pages

Horizontal

- Horizontal Shift
- E-W Width
- Pin Phase
- Pin Amp
- Upper Corner Correction
- Lower Corner Correction

Vertical

- Vertical Amplitude
- S Correction
- Vertical Shift
- Vertical Linearity
- Vertical angle
- Vertical bow

Just in case the TV set requires a full geometries adjustment, please proceed first with Vertical according to the above order, and after that, adjust Horizontal according to the above order.

Horizontal Shift

Adjust the horizontal shift so that the picture is centred.
The effect of this adjustment is shown in figure 2.

- When the volume up button is pressed, the picture moves to the left.
- When the volume down button is pressed, the picture moves to the right.
- Press the stand-by button on the remote control to store.

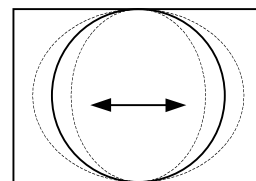

Fig.2

E-W Width

Adjust the E-W Width so that 9% over-scan is achieved.
The effect of this adjustment is shown in figure 3.

- When the volume up button is pressed, horizontal scanning increases.
- When the volume down button is pressed, horizontal scanning decreases.
- Press the stand-by button on the remote control to store.

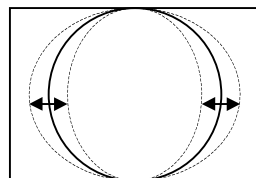

Fig.3

Pin Phase

Adjust the Pin Phase so that the picture is symmetrical top and bottom.
The effect of this adjustment is shown in figure 4.

- When the volume up button is pressed, side pincushion changes.
- When the volume down button is pressed, side pincushion changes.
- Press the stand-by button on the remote control to store.

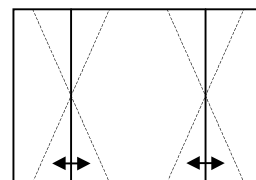

Fig.4

Pin Amp

Adjust the Pin Amplitude so that the picture is centred.
The effect of this adjustment is shown in figure 5.

- When the volume up button is pressed, side pincushion changes from pincushion to barrel shape.
- When the volume down button is pressed, side pincushion changes from pincushion to barrel shape.
- Press the stand-by button on the remote control to store.

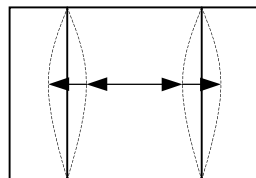

Fig.5

Upper Corner Correction

Adjust the Upper Corner Correction so that the picture is centred.
The effect of this adjustment is shown in figure 6.

- When the volume up button is pressed, side pincushion changes from pincushion to barrel shape.
- When the volume down button is pressed, side pincushion changes from pincushion to barrel shape.
- Press the stand-by button on the remote control to store.

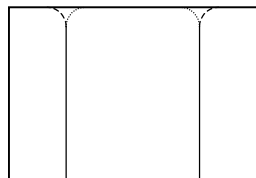

Fig.6

Lower Corner Correction

Adjust the Lower Corner Correction so that the picture is centred.
The effect of this adjustment is shown in figure 7.

- When the volume up button is pressed, side pincushion changes from pincushion to barrel shape.
- When the volume down button is pressed, side pincushion changes from pincushion to barrel shape.
- Press the stand-by button on the remote control to store.

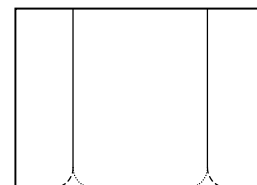

Fig.7

Vertical Linearity

Adjust the Vertical Linearity so that the upper and lower parts of the picture are symmetrical.
The effect of this adjustment is shown in figure 8.

- When the volume up button is pressed, the upper picture scanning decreases and the lower picture scanning increases.
- When the volume down button is pressed, the upper picture scanning increases and the lower picture scanning decreases.
- Press the stand-by button on the remote control to store.

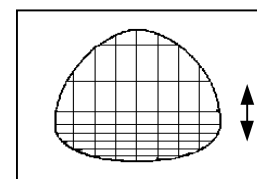

Fig.8

Vertical Angle

Adjust the Vertical Amplitude so that the picture is centred.
The effect of this adjustment is shown in figure 9

- When the volume up button is pressed, the vertical angle changes to right.
- When the volume down button is pressed, the vertical angle changes to left.
- Press the stand-by button on the remote control to store.

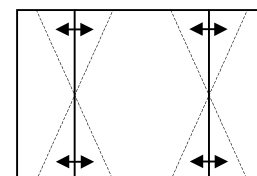

Fig.9

Vertical Bow

Adjust the Vertical Bow so that the picture is centred.
The effect of this adjustment is shown in figure 10

- When the volume up button is pressed, the vertical bow changes to right.
- When the volume down button is pressed, the vertical bow changes to left.
- Press the stand-by button on the remote control to store.

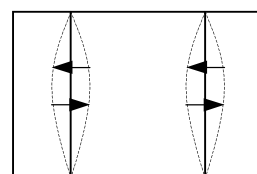

Fig.10

Vertical Amplitude

Adjust the Vertical Amplitude so that the picture is over-scanned.
The effect of this adjustment is shown in figure 11.

- When the volume up button is pressed, the vertical size of the picture increases.
- When the volume down button is pressed, the vertical size of the picture decreases.
- Press the stand-by button on the remote control to store.

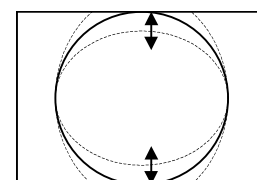

Fig.11

S Correction

Adjust the S Correction so that the picture symmetrical between the top, centre and bottom.
The effect of this adjustment is shown in figure 12.

- When the volume up button is pressed, the top and bottom scanning increases and the centre scanning decreases.

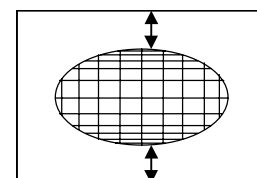

Fig.12

- When the volume down button is pressed the top and bottom scanning decreases and the centre scanning increases.
- Press the stand-by button on the remote control to store.

Vertical Shift

Adjust the Vertical Shift so that the picture is centred.
The effect of this adjustment is shown in figure 13.

- When the volume up button is pressed, the picture moves down.
- When the volume down button is pressed, the picture moves up.
- Press the stand-by button on the remote control to store.

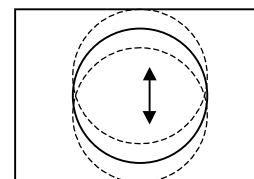

Fig.13

Colour Adjustments

The following adjustments should only be carried out when the CRT, IC801 are replaced.

G2, Cut Off and Gain Adjustments

1. Follow the procedure below to set the G2

- 1.1 Tune the set to the output of a signal generator (cross hatch pattern).
- 1.2 In the user menu, set contrast to 80/100 and brightness to 40/100.
- 1.3 Connect the oscilloscope to the red cathode and adjust G2 to read 135V on the sensor pulse as in the drawing:

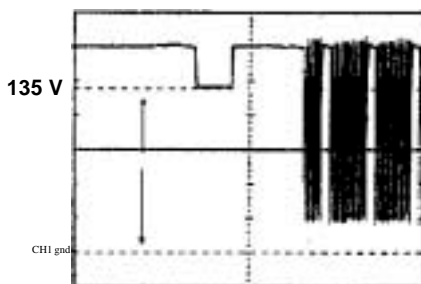

NOTE:

Oscilloscope should be adjusted for vertical TV field trigger and synchronized with video signal.

2. Follow the procedure below to set the Cut Off.

- 2.1 Adjust G2.
- 2.2 Tune a white pattern.
- 2.3 Adjust colour to minimum.
- 2.4 Position colorimeter in the centre of screen.
- 2.5 Adjust brightness and contrast to obtain a luminance of ≈ 20 NITS.
- 2.6 Operate in Service Mode and select location RED CUT OFF, GREEN CUT OFF and BLUE CUT OFF, to obtain colour coordinates:

$$X=0.290 \pm 0.015 \quad Y=0.300 \pm 0.015$$

To increase press volume-up button and to decrease press volume down button.

RED CUT OFF	alter «X» coordinate.
GREEN CUT OFF	alter «Y» coordinate.
BLUE CUT OFF	alter «X» and «Y» coordinate.

3. Follow the procedure below to set the GAIN.

- 3.1 Using brightness and contrast buttons, select a luminance of ≈ 120 NITS.
- 3.2 Operate in Service Mode and select location RED GAIN, GREEN GAIN and BLUE GAIN, to obtain colour coordinates:

$$X=0.290 \pm 0.015 \quad Y=0.300 \pm 0.015$$

To increase press volume-up button and to decrease press volume down button.

RED CUT OFF	alter «X» coordinate.
GREEN CUT OFF	alter «Y» coordinate.
BLUE CUT OFF	alter «X» and «Y» coordinate.

- 3.3 Exit Service Mode and check colour coordinates «X» and «Y» at 20 and 120 NITS. It may be necessary to repeat procedure 2 and 3 of Colour Adjustments.

Changing NVM Data

To change the data contained within the Non Volatile Memory, it is necessary to first select the page the data is stored in, then the position and finally to change the data itself. The procedure below outlines this process.

1. While on ALTER NVM PAGE, use the volume up/down buttons to change this data (data is shown in hexadecimal format).
2. Press the channel up button and ALTER NVM POSITION appears, use the volume up/down buttons to change this data (data is shown in hexadecimal format).
3. Press the channel up button and ALTER NVM VALUE appears, use the volume up/down buttons to change this data (data is shown in hexadecimal format).

4. Once this data has been set, press the standby button to store.
5. If another NVM value has to be changed, use the channel down button to select the page or position and repeat as necessary.

Note:

DO NOT change any NVM data, unless you have been advised to do so by a Sharp representative. If data is incorrectly changed, serious damage may occur to the receiver.

Contrast Adjustments

Three types of contrast levels can be varied as listed below:

- TELETEXT MIX MODE CONTRAST
- TELETEXT CONTRAST
- OSD CONTRAST

Use the volume up/down buttons to adjust to a suitable level, then press the standby button to store.

DVCO Adjustment (PAL)

Carry out the DVCO Adjustment (PAL) as shown below:

1. Receive a Phillips pattern signal.
2. While in the DVCO ADJUSTMENT (PAL) menu, press the standby button.
3. The adjustment will be carried out automatically and stored.

DVCO Adjustment (NTSC)

No adjustment required.

Auto Installation On/Off

To return the receiver to the original Auto Installation mode, using the volume up or down button, set the Auto Installation On/Off to On. This setting is automatically stored and when the receiver is turned on the next time it will start up in Auto Installation mode.

AGC Adjustment

To correctly align the Automatic Gain Control, follow the procedure outlined below:

1. Tune the set into a pattern generator on CH10.
2. Adjust the signal strength of the pattern generator to 57uV
3. Enter the service mode.
4. Enter the AGC Adjustment menu.
5. Press the standby button on the remote control.
6. The adjustment will be carried out and stored automatically.

AFT Adjustment

To correctly align the Automatic Fine Tune, follow the procedure outlined below:

1. Tune the set into a pattern generator on CH69.
2. Enter the service mode.
3. Enter the AFT Adjustment menu.
4. Press the standby button on the remote control.
5. The adjustment will be carried out and stored automatically.

MOTHER UNIT (F7240N7A) PWB COMPONENT LOCATION TABLES.

Component Side.

Ref No	Xum	Yum	Ref No	Xum	Yum	Ref No	Xum	Yum	Ref No	Xum	Yum	Ref No	Xum	Yum	Ref No	Xum	Yum
(A)	19558	182118	C220	292608	84328	C611	102616	33274	D1815	158242	179070	J162	262127	103886	J162	262127	103886
(AA)	20066	207010	C228	310896	61722	C611A	100330	35052	D510	186944	104394	J163	267462	102870	J163	267462	102870
(AV)	166649	12496	C229	291338	51816	C613	147066	68072	D516	120396	23368	J164	269748	100584	J164	269748	100584
(AV.)	142494	34620	C305	255016	120904	C615	168656	79502	D603	98806	58674	J165	272542	100584	J165	272542	100584
(CC)	227076	223774	C306	249174	120142	C616	141224	129286	D604	103378	42164	J166	274828	100584	J166	274828	100584
(CV1)	277114	26670	C311	272034	114554	C618	81280	33274	D605	99314	59944	J167	277622	100584	J167	277622	100584
(CW)	8636	157734	C313	279146	116078	C619	139192	51054	D606	125984	93218	J168	279908	100584	J168	279908	100584
(EW)	121920	22860	C314	283972	113030	C620	137414	58928	D608	66802	30226	J169	297180	109220	J169	297180	109220
(F)	104902	72898	C315	289560	116840	C631	118618	81026	D609	91440	11938	J17	89408	202946	J17	89408	202946
(FV)	264668	36322	C322	290322	109982	C632	100076	7620	D610	140208	92964	J170	318008	107442	J170	318008	107442
(FV.)	204216	222504	C323	294386	109982	C634	78486	45974	D611	99568	104394	J171	93218	90170	J171	93218	90170
(G)	63754	194310	C324	299974	109220	C637	69850	30226	D612	88646	90932	J172	131572	93218	J172	131572	93218
(G2)	181864	167894	C325	304038	109220	C638	94234	9652	D613	128016	60706	J173	134112	93218	J173	134112	93218
(H)	143764	109728	C326	301752	116586	C641	87122	33274	D621	102616	95504	J174	155194	91948	J174	155194	91948
(H.)	158242	204216	C329	307848	114046	C642	84582	39370	D622	188976	91694	J175	157480	91948	J175	157480	91948
(HD)	235204	222758	C332	299974	144526	C644	178816	91440	D623	166878	63754	J176	159766	91948	J176	159766	91948
(K)	222504	71628	C341	234696	218440	C648	78740	22352	D701	13462	175514	J177	162052	91948	J177	162052	91948
(K.)	130048	180848	C342	258572	114554	C651	113284	60706	D702	14478	167640	J178	166624	91948	J178	166624	91948
(L2)	314960	6858	C343	264668	114808	C652	104648	42164	D703	48006	162560	J179	171704	91948	J179	171704	91948
(L3)	172466	203708	C351	273812	220980	C701	37338	215138	D704	37592	166878	J180	178308	97282	J180	178308	97282
(L6)	24892	168656	C352	267716	220472	C702	62738	189484	D707	62738	185166	J183	186690	91440	J183	186690	91440
(MO)	134874	18542	C353	292100	237998	C703	10922	172212	D708	64770	198628	J185	191262	91440	J185	191262	91440
(PW)	9652	137414	C356	258318	230632	C704	48768	170942	D711	54610	142240	J187	205740	103378	J187	205740	103378
(RGB.)	236474	18542	C358	272288	230378	C705	24892	122428	D712	25908	136906	J189	312166	98044	J189	312166	98044
(RT)	257606	188163	C361	314198	228854	C706	76454	223520	D714	117856	142494	J190	182372	83566	J190	182372	83566
(S)	319786	221996	C362	267716	232156	C707	98806	230632	D716	64516	153670	J191	211836	89154	J191	211836	89154
(SA)	316230	161798	C363	305054	228600	C710	33782	158496	D718	96012	160274	J192	211836	86614	J192	211836	86614
(SB)	316230	188976	C365	266954	208280	C711	45466	145796	D719	97536	139954	J193	211836	84074	J193	211836	84074
(SC)	258318	128524	C368	289306	219456	C713	35814	146304	D720	110490	120904	J194	211836	81534	J194	211836	81534
(SS)	178308	233680	C370	300228	197358	C714	33274	106680	D722	100838	121412	J199	248920	83312	J199	248920	83312
(STB1)	255473	153466	C372	272034	213360	C718	118872	193040	D731	8636	213614	J201	257810	84328	J201	257810	84328
(STB2)	97790	204470	C373	300482	219456	C719	123952	210566	D734	27940	214376	J203	276098	83312	J203	276098	83312
(STB3)	244348	143510	C376	316738	212090	C720	124206	111506	D735	118872	124714	J206	289306	93980	J206	289306	93980
(VS)	216916	212852	C377	317500	205486	C721	116332	166624	D803	188976	61722	J207	77978	71374	J207	77978	71374
AV	249428	33274	C378	305816	213614	C723	146304	149606	F701	35306	192024	J208	139446	80010	J208	139446	80010
C1	24892	122428	C381	258318	235458	C724	90678	209296	F702	169926	212344	J209	139446	77470	J209	139446	77470
C1001	271272	148082	C382	294640	197358	C739	87376	198120	FB1	35306	52832	J210	139446	74930	J210	139446	74930
C1027	233426	200152	C415	211074	22606	C745	63754	198628	FB1002	117602	227076	J211	166116	73406	J211	166116	73406
C1031	303784	153416	C422	266446	25654	C746	37846	173990	FB301	183642	37338	J212	182372	78486	J212	182372	78486
C1032	243078	199644	C426	278384	19050	C770	101092	186944	FB302	204978	20574	J214	193548	70866	J214	193548	70866
C1807	142748	199136	C430	171704	222504	C802	205232	72390	FB303	253492	24638	J216	231648	80010	J216	231648	80010
C1811	157480	190500	C431	181356	222504	C804	218694	66548	FB501	148590	125730	J221	271272	72136	J221	271272	72136
C1812	167640	182880	C433	256794	33528	C812	246634	72390	FB601	110490	58674	J222	271272	70104	J222	271272	70104
C1814	188976	166116	C437	274828	42926	C815	229616	97790	FB603	104521	86106	J223	270256	79756	J223	270256	79756
C1823	134366	199136	C501	159766	145796	C818	252476	69596	FB701	10414	107442	J224	280416	54864	J224	280416	54864
C1824	155956	182880	C504	143002	115824	C820	282194	75946	FB702	50038	142240	J225	318516	71628	J225	318516	71628
C1825	157988	198374	C509	133350	124714	C821	287274	34290	FB703	93980	124206	J228	188976	59690	J228	188976	59690
C1826	169672	198374	C511	167132	141478	C822	258572	69088	FB704	99822	108712	J230	188976	57658	J230	188976	57658
C204	317246	45720	C514	174498	69596	C825	227584	66548	FB705	110490	147828	J231	190754	67056	J231	190754	67056
C205	317500	51562	C520	179832	107188	CF202	313944	85090	IC1002	287020	176530	J232	190754	64516	J232	190754	64516
C206	307340	81026	C524	176784	141478	CF701	96266	220218	IC1005	286512	157988	J234	203200	57404	J234	203200	57404
C209	317500	39116	C526	154686	76581	CN3	232994	241985	IC1008	118110	239471	J236	215392	56388	J236	215392	56388
C210	313436	107696	C528	133604	46736	D1001	130301	229997	IC1801	148082	182118	J24	232664	206502	J24	232664	206502
C211	301752	82042	C536	178816	148590	D1002	142290	229997	IC203	294640	33528	J241	271272	68072	J241	271272	68072
C215	292608	24638	C601	100330	49784	D1809	173736	189484	IC2401	214122	180594	J242	271272	66040	J242	271272	66040
C218	293624	9906	C607	73914	91440	D1813	158496	175514	IC2402	214376	197612	J243	269367	62738	J243	269367	62738
C219	314452	79502	C610	121920	53340	D1814	158242	172466	IC301	287274	230378	J246	188976	53340	J246	188976	53340

MOTHER UNIT (F7240N7A) PWB COMPONENT LOCATION TABLES.

Component Side.

Ref No	Xum	Yum	Ref No	Xum	Yum	Ref No	Xum	Yum	Ref No	Xum	Yum	Ref No	Xum	Yum	Ref No	Xum	Yum
J248	189230	44958	JF32	203962	129286	JF32	203962	129286	L2401	203962	152400	R1832	168402	170180	R641	129032	93218
J249	203200	55118	JF33	206502	129286	JF33	206502	129286	L2402	203962	149352	R1833	158242	169164	R643	135890	117348
J250	205486	37846	JF34	209042	129286	JF34	209042	129286	L301	288036	142240	R1834	173482	170180	R651	69850	17018
J251	215392	54102	JF35	211582	129286	JF35	211582	129286	L315	253746	210566	R1835	158242	163068	R703	20574	234950
J252	220218	37338	JF40	178562	115316	JF40	178562	115316	L316	253746	205486	R1836	191008	158750	R713	14224	107950
J253	240284	50800	JF48	128016	124460	JF48	128016	124460	L317	265938	240792	R229	224028	124460	R714	36576	105918
J255	240284	48514	JF50	89916	23114	JF50	89916	23114	L318	192786	223012	R230	232664	104902	R715	21590	157480
J260	269494	32258	JF51	102870	26670	JF51	102870	26670	L350	257556	219456	R231	289306	42418	R716	25908	139446
J265	194310	32765	JF53	53594	211836	JF53	53594	211836	L351	257556	215392	R232	316738	25908	R721	20574	229870
J266	196850	32765	JF54	66802	211836	JF54	66802	211836	L352	303530	237744	R233	316738	23368	R723	64008	157226
J269	241554	41656	JF55	113792	93218	JF55	113792	93218	L353	312674	219710	R234	313944	14478	R727	133858	144526
J27	253492	208026	JF56	87884	75692	JF56	87884	75692	L501	163322	116586	R306	308610	148590	R728	114808	176784
J270	241554	39116	JF57	84328	73152	JF57	84328	73152	L502	150876	140716	R307	311150	148590	R730	23622	103378
J271	287020	38354	JF6	297942	89154	JF6	297942	89154	L503	169164	91948	R315	241808	215138	R741	75184	167132
J274	264414	19558	JF61	31242	237236	JF61	31242	237236	L603	123698	33782	R359	310642	210058	R742	96520	174244
J275	290576	19558	JF63	136906	193040	JF63	136906	193040	L603A	123698	33782	R408	157226	40386	R763	65024	171450
J278	290322	9906	JF64	136906	190754	JF64	136906	190754	L604	81788	13208	R418	240792	34036	R770	74422	191770
J28	241681	186690	JF65	139192	180086	JF65	139192	180086	L604A	80772	12700	R419	220980	27432	R771	81280	184912
J280	209550	35814	JF66	133350	162052	JF66	133350	162052	L605	100076	18796	R420	230378	36576	R778	20574	240030
J284	14224	139700	JF67	205740	105664	JF67	205740	105664	L606	105918	86106	R424	237998	24638	R790	78486	230124
J288	166370	69596	JF73	164846	190754	JF73	164846	190754	L609	82296	82042	R425	237998	27432	R791	78486	232664
J297	228600	151892	JF8	68580	6350	JF8	68580	6350	L609A	69088	72390	R426	220980	24638	R792	96774	224536
J30	303022	205740	JF9	68580	8890	JF9	68580	8890	L611	59436	13462	R436	271018	19304	R814	229768	59436
J300	166370	67056	JL1	141224	19812	JL1	141224	19812	L612	117094	12192	R451	202946	37846	R815	203200	59690
J301	312928	32258	JL1.	237998	197612	JL1.	237998	197612	L701	60172	211658	R455	188976	50546	REF10	53695	-4166
J303	252984	101346	JL10	292608	145796	JL10	292608	145796	L701A1	59182	212852	R464	257048	44704	REF1A	127000	164592
J304	253746	161544	JL10.	202946	63754	JL10.	202946	63754	L702	48768	184912	R501	176022	100838	REF4	238252	166878
J305	307848	193294	JL11	209804	154940	JL11	209804	154940	L703	41656	188468	R503	153924	115824	S701	20497	247015
J306	64262	18288	JL11.	250291	157911	JL11.	250291	157911	L705	122936	148082	R508	182880	130048	S702	48514	238201
J307	272034	85598	JL11..	236880	160274	JL11..	236880	160274	L801	204978	66548	R518	160782	103124	S703	60502	238201
J309	257810	86614	JL12	215900	33274	JL12	215900	33274	L803	218440	105156	R519	182372	81026	S704	72517	238201
J31	305562	193294	JL12,	262382	68072	JL12,	262382	68072	L804	223520	105156	R526	186944	136652	S705	84505	238201
J311	230886	138684	JL12.,	268224	68072	JL12.,	268224	68072	LP701	38506	235991	R530	184150	91440	SF201	294894	72644
J312	196088	139446	JL12.	277876	57404	JL12.	277876	57404	M1000	98501	240461	R533	164338	91948	SF202	290322	72644
J314	282194	59944	JL14	247142	64262	JL14	247142	64262	POR701	62738	179578	R534	182880	127508	SF203	296672	61468
J316	143256	91948	JL14.	150622	37084	JL14.	150622	37084	Q2	71120	56134	R536	136652	34798	T601	33655	51003
J317	94742	195326	JL17	130555	119634	JL17	130555	119634	Q502	188722	113284	R541	205232	110490	T701	74599	127635
J318	214630	128524	JL17.	185420	115824	JL17.	185420	115824	Q601	71120	56134	R550	189484	136652	TH201	304495	5486
J319	210540	79248	JL18	255574	162585	JL18	255574	162585	Q602	97282	100330	R553	142494	121920	X1002	245999	154940
J32	310134	193294	JL19	319786	11176	JL19	319786	11176	Q605	90170	79248	R563	168148	105156	X2401	217678	153924
J320	103378	138684	JL2	263906	188976	JL2	263906	188976	Q701	45720	128016	R603	148336	91948	X301	314706	115824
J321	101600	108712	JL2.	168656	60198	JL2.	168656	60198	Q701A1	45720	128016	R606	79248	99314	X801	240538	68326
J322	188976	48006	JL2..	234950	62484	JL2..	234950	62484	Q711	151384	220726	R608	145796	91948			
J323	240284	45466	JL26	256540	60706	JL26	256540	60706	Q718	152146	226822	R609	136906	82804			
J326	133858	107188	JL27	245110	59436	JL27	245110	59436	Q912	129794	199644	R610	128778	45974			
J33	114300	183896	JL28	258064	62484	JL28	258064	62484	R1008	219456	145034	R611	118364	16510			
J331	257048	42164	JL31	179705	59436	JL31	179705	59436	R1018	261873	150368	R611A	117602	15748			
J343	222504	59182	JL31.	175514	86614	JL31.	175514	86614	R1022	261873	147320	R612	84074	75692			
J344	64516	232664	JL40	225552	110490	JL40	225552	110490	R1027	232664	204216	R613	131063	60198			
J347	227838	36576	JL40.	156210	223520	JL40.	156210	223520	R1036	129794	220980	R614	72644	23876			
J348	225298	36576	JL6	262890	224790	JL6	262890	224790	R1047	275590	191770	R616	151130	92710			
J349	222758	36576	JL6.	271018	141732	JL6.	271018	141732	R1050	278130	191770	R617	82042	94234			
J357	257556	139446	JL7	239268	163068	JL7	239268	163068	R1055	273050	191770	R618	205232	113538			
J358	157988	55118	JL7.	200152	63754	JL7.	200152	63754	R1058	248920	132334	R619	125476	131826			
J359	171958	131826	L1801	167386	191262	L1801	167386	191262	R1059	251460	132029	R620	224282	144272			
J362	157734	200914	L201	313944	88900	L201	313944	88900	R1801	132080	169418	R623	122428	93218			
J363	142494	205486	L203	289179	16764	L203	289179	16764	R1831	158242	166116	R628	141986	104140			

MOTHER UNIT (F7240N7A) PWB COMPONENT LOCATION TABLES.

Copper Side.

Ref No	Xum	Yum	Ref No	Xum	Yum	Ref No	Xum	Yum	Ref No	Xum	Yum	Ref No	Xum	Yum	Ref No	Xum	Yum
C1002	275590	143510	C2407	217170	185420	C419	256286	16764	C639	96012	81026	D204	314960	56134	D715	69088	149352
C1005	262890	163626	C2408	211074	208026	C420	256286	25146	C640	92456	77216	D205	317246	99314	D721	138684	144526
C1014	299212	174625	C2409	213106	116586	C421	249174	25146	C643	217932	167640	D2401	215138	181864	D724	138938	238760
C1015	120396	230000	C309	272542	135382	C427	270256	43434	C645	155448	63754	D2402	210820	173482	D725	148844	238252
C1017	214376	151638	C310	274320	135382	C428	171196	228600	C646	154686	58928	D2403	210820	168910	D726	84328	146304
C1018	247345	192379	C312	274066	123444	C429	177800	229870	C653	90678	101092	D2404	210820	171196	D727	70866	131826
C1019	242062	150876	C316	279400	123444	C432	265176	34036	C712	44958	118618	D301	310388	201422	D728	72898	165354
C1020	242062	152908	C317	287020	124460	C434	220726	46482	C715	36576	104394	D302	261873	120396	D729	82296	184150
C1021	237286	175056	C318	289306	124460	C435	224282	45720	C716	65531	155702	D303	270256	115062	D730	35814	147828
C1022	243840	156718	C319	250444	230378	C436	226822	45720	C717	66294	159004	D304	259588	120396	D732	82296	200914
C1023	218694	81280	C320	250444	225425	C438	260349	36576	C722	113284	141224	D305	257302	118872	D733	87376	198628
C1024	223774	82296	C321	288290	141732	C439	278384	46482	C725	64516	233934	D401	149860	30480	D801	259842	87122
C1025	219456	84582	C327	299720	124206	C440	277114	50800	C728	81788	205486	D402	157226	32765	D802	257302	87122
C1026	264160	158953	C328	305054	124206	C441	272542	50800	C730	49784	235966	D403	152908	23622	D804	207264	65531
C1028	291922	160477	C330	309626	124206	C442	159766	50800	C731	60452	236220	D404	147066	18796	FB1001	242062	146558
C1029	291846	173482	C331	309880	135890	C443	280924	23622	C732	72644	236220	D405	215392	20066	FB801	237490	65531
C1030	289052	43434	C333	311912	124206	C444	239776	29210	C733	83312	235712	D406	221742	23368	FB802	246634	80264
C1033	262890	165531	C334	313690	118110	C445	236220	30226	C735	118618	144018	D407	241300	22860	IC1001	250190	172212
C1034	242138	179806	C335	318516	118110	C446	220726	27940	C737	73660	167132	D408	235458	22860	IC1003	275844	148844
C1035	238760	179324	C336	232410	237998	C447	247396	62484	C738	33274	149606	D409	229870	25146	IC1004	298958	153162
C1036	254762	189738	C337	234188	237998	C451	229362	221488	C740	118872	169672	D410	223774	18288	IC1006	291338	150876
C1037	268986	180086	C338	250444	236982	C502	162814	133858	C741	120396	144018	D411	232664	13462	IC1007	283464	148844
C1038	302768	181737	C339	250444	227076	C503	163068	126746	C742	124968	149860	D412	206756	37592	IC201	307340	70104
C1039	304292	174244	C340	235712	220726	C505	157226	126492	C743	106172	150114	D413	204216	37592	IC202	302768	97282
C1040	235153	179705	C350	289814	228600	C506	156718	131572	C749	81280	176276	D414	197104	24130	IC401	273558	32258
C1801	134366	165862	C354	284734	231140	C507	165608	132080	C801	213614	77470	D415	166624	25908	IC502	163576	116332
C1805	140208	196850	C357	265684	234188	C508	158242	123952	C803	221742	78486	D416	197866	17780	IC503	161544	79502
C1806	142748	199136	C359	277114	236855	C510	152908	132842	C807	230124	63754	D417	220472	12192	IC702	85344	222504
C1813	164084	202946	C360	297942	239268	C512	193040	102108	C808	233172	65786	D418	278892	40132	IC707	113030	156972
C1815	139446	191770	C364	306070	228600	C513	157988	117856	C809	227838	87884	D419	280924	34036	IC708	74422	173228
C1820	135382	188468	C366	266954	208534	C515	167132	53594	C811	252730	77978	D420	162306	13208	J126	267970	142494
C1821	135128	177038	C367	290830	211074	C516	157988	74168	C813	243840	80264	D421	153416	13208	J2	258064	236474
C1822	136144	165862	C369	289560	214122	C517	158648	70866	C814	242062	80264	D422	168656	32004	J218	234696	71374
C1827	137922	202184	C371	277622	211582	C518	147320	65531	C816	237490	97028	D423	189738	27686	J219	236474	71374
C203	317754	63754	C374	281432	213868	C521	172212	112776	C817	252222	70104	D424	189738	29972	J220	234950	65786
C207	303530	59436	C375	306578	220980	C522	156718	135382	C819	279908	44450	D425	176022	32004	J240	244094	68580
C208	304546	56388	C379	304038	212852	C523	189738	128016	C823	241046	98298	D426	224536	229743	J279	308356	9906
C212	299974	45974	C380	283972	137414	C525	155752	72034	C824	207010	74676	D502	139446	56642	J281	160274	133858
C213	299974	50292	C383	272542	131063	C527	150876	74676	C826	215646	62992	D503	138938	61214	J283	293878	179578
C214	302514	38100	C386	250444	223774	C529	165608	58674	C827	238506	80264	D504	139446	54356	J286	290830	100076
C216	306832	27686	C387	250444	233680	C530	155956	82804	C828	214376	99060	D506	150622	70866	J289	296926	55118
C217	306832	21336	C401	176022	25908	C531	171196	79502	D1003	236474	132080	D507	193167	106172	J294	236982	128778
C221	315468	59690	C402	179070	29972	C532	169418	118364	D1004	269240	151638	D508	184658	106172	J302	234746	172720
C222	307594	59436	C403	184150	36576	C533	172212	52324	D1005	303784	159258	D509	132588	119126	J310	234696	156718
C223	300736	8382	C404	189992	35052	C534	158242	122174	D1006	221742	115570	D515	152654	70866	J313	104394	239522
C224	297434	7366	C405	180086	36576	C535	174193	46786	D1007	253492	109728	D601	175006	75438	J324	247904	69088
C225	296926	13716	C406	185674	29210	C537	142494	69850	D1008	251206	109728	D614	77216	100838	J325	247904	67310
C226	314452	95504	C408	159004	18542	C538	143764	65531	D1009	264795	156006	D615	219710	105156	J332	209296	72136
C227	316230	95504	C409	180086	13716	C539	152400	79756	D1010	286512	161544	D617	229362	101346	J335	238760	128778
C230	289052	55118	C410	177800	18288	C540	162560	107442	D1011	249986	153466	D618	219456	151892	J336	246888	155448
C231	316992	77089	C411	189230	21590	C541	255016	97790	D1012	307594	156972	D619	103632	83566	J338	259715	144145
C2401	217932	165862	C412	188214	17272	C542	214376	101092	D1804	137160	197104	D620	97028	83058	J339	254431	144145
C2402	217932	163830	C413	192532	22606	C606	193294	86106	D1805	132334	200914	D624	29718	73660	J340	93472	200152
C2403	215138	185420	C414	186182	17272	C617	229362	97790	D1810	132080	164846	D625	74676	12446	J341	319278	185420
C2404	219202	176022	C416	250952	13462	C633	97282	98044	D1811	153162	187706	D706	83058	212852	J342	319278	183388
C2405	210058	181864	C417	258064	16764	C635	144018	100584	D1812	145542	198882	D710	93726	211582	J345	209296	229108
C2406	215138	176530	C418	248920	18288	C636	183896	119126	D203	308102	12192	D713	36068	139700	J350	234188	217678

MOTHER UNIT (F7240N7A) PWB COMPONENT LOCATION TABLES.

Copper Side.

Ref No	Xum	Yum	Ref No	Xum	Yum	Ref No	Xum	Yum	Ref No	Xum	Yum	Ref No	Xum	Yum	Ref No	Xum	Yum
J351	319532	193040	JF78	310642	177038	Q903	147574	160528	R1809	139700	179578	R248	283464	9652	R409	160782	23622
J352	319024	189484	JF79	233248	177622	Q904	135382	183642	R1810	135128	175260	R249	318262	48514	R410	210312	34798
J353	267462	135890	JF80	234442	87884	Q905	139954	174498	R1811	150876	191262	R251	281686	9652	R411	204978	18034
J354	316992	99822	L1802	153162	187706	Q906	141478	170434	R1812	139446	193548	R252	287020	6350	R412	175768	13716
J355	121412	232156	L202	309372	41656	Q907	133604	191770	R1813	140208	185420	R253	290322	93980	R413	182626	23114
J356	288290	32512	L204	311150	61214	Q908	139446	188722	R1814	136398	192024	R254	294386	49276	R414	185166	13716
J360	233172	212598	L205	307340	48514	Q909	140462	182372	R1815	135382	186690	R255	291338	51562	R415	189230	23622
J361	231394	212598	L601	29972	77470	Q913	146558	198374	R1816	150876	193040	R256	296164	49276	R416	212090	34798
J365	113792	219202	Q1001	227330	191516	R1	84836	157480	R1830	132080	195834	R257	286004	57150	R417	216408	14732
J369	241046	68326	Q1002	126238	234696	R1001	297942	160020	R1837	168148	180848	R258	287274	48006	R421	223774	26924
J370	238252	71374	Q1003	139954	223012	R1002	299720	160020	R1839	165862	202946	R259	313944	88900	R422	236474	26162
J371	238506	83312	Q1004	309118	162814	R1003	229616	212598	R1841	139954	201676	R301	246888	117094	R423	239268	26162
J372	237286	176733	Q1005	237490	150622	R1004	257810	105918	R1842	136144	202184	R302	251460	116840	R427	229616	18288
J51	320802	189484	Q1006	253492	204978	R1005	272542	154940	R1843	150876	195072	R303	251460	121412	R428	246634	13462
J65	299720	170942	Q1007	254203	184785	R1012	117094	237236	R1844	146050	195072	R304	246888	121412	R429	256032	13462
J701	93726	138938	Q201	252730	37084	R1017	116078	217170	R203	256032	37084	R308	250444	235331	R430	254508	25146
J98	268986	146304	Q207	299974	42926	R1019	256108	144145	R204	306578	87630	R309	241300	231140	R431	250952	25146
JF1001	37592	18796	Q208	299974	88138	R1020	257810	144145	R205	315722	82804	R310	250444	232029	R432	258064	25146
JF1002	39370	18796	Q209	286766	9398	R1021	312420	197358	R208	290322	95758	R311	250444	228727	R433	252730	25146
JF1003	41148	18796	Q210	286766	51816	R1023	251460	143764	R209	290322	97536	R312	244221	219710	R434	169418	37338
JF1004	42926	18796	Q2401	216408	116586	R1024	283972	172466	R210	318516	95504	R313	250444	222123	R435	161036	36322
JF1005	44704	18796	Q302	314960	201930	R1025	304292	176530	R211	297688	100838	R314	245110	216662	R437	267970	45466
JF1006	46482	18796	Q303	319278	200406	R1026	240030	198755	R215	320802	95504	R316	235458	225806	R445	271907	39370
JF1007	48260	18796	Q304	306832	200660	R1028	221488	87884	R216	316992	51816	R317	235458	227584	R447	169418	225806
JF1008	50038	18796	Q305	257810	224790	R1029	210058	166878	R217	311404	81788	R318	276606	111252	R448	181102	223520
JF11	285750	23876	Q306	259080	216408	R1030	211328	176784	R218	315976	15748	R319	261619	116586	R449	265684	39370
JF12	280924	28194	Q403	264668	45466	R1031	209042	176784	R219	309372	38608	R320	265176	114554	R450	167386	37338
JF15	104140	83566	Q404	164338	37592	R1032	236982	134620	R220	310388	52832	R321	302006	106426	R452	201930	38862
JF16	103886	88392	Q405	172974	37338	R1033	236982	156718	R225	295910	45720	R322	306070	106172	R453	170180	23876
JF2	300990	32512	Q406	201422	28194	R1035	233426	191262	R226	294894	55118	R323	292354	106680	R454	212598	41402
JF20	211074	226060	Q408	284988	29718	R1037	136906	223012	R227	299974	52070	R350	255016	216662	R456	200406	42926
JF21	207518	226060	Q501	176022	69596	R1038	139700	233426	R228	299974	48514	R351	257556	227838	R457	170180	25654
JF22	209296	226060	Q503	182118	80518	R1039	144780	233426	R235	308356	17526	R352	280416	232156	R458	285750	21844
JF24	108458	99466	Q505	192532	123698	R1040	130301	233426	R236	308356	14224	R353	292354	240538	R459	279908	18542
JF3	300990	30480	Q506	147828	60960	R1041	241300	160274	R237	304800	83312	R354	254254	212090	R460	204978	20574
JF30	212598	147320	Q507	188214	119126	R1042	252984	189738	R238	304800	87630	R355	256540	212090	R461	285750	25908
JF37	275082	37592	Q603	108458	100838	R1043	260984	186258	R239	237236	111506	R356	284988	214376	R462	214630	14732
JF38	216408	45212	Q604	102616	97282	R1044	296164	160020	R240	313944	48514	R357	310388	217678	R463	254000	40132
JF39	212852	45466	Q606	183896	122174	R1045	265684	183388	R2401	219202	185420	R358	318770	208280	R465	279146	38100
JF4	308356	44450	Q607	275336	180848	R1046	262255	167436	R2402	211836	164592	R360	308356	204724	R466	282702	23622
JF41	186690	104140	Q608	218948	157226	R1048	114046	199898	R2403	217170	113538	R361	319278	203454	R467	278892	40386
JF44	237490	65531	Q702	27432	138684	R1049	263398	183388	R2404	211328	116586	R362	257556	221742	R468	287274	39116
JF46	143002	222758	Q703	28448	144780	R1051	287020	43434	R2405	210058	179832	R363	257556	219964	R469	251206	32512
JF47	132842	226568	Q708	68580	229362	R1052	291084	43434	R2406	211836	162814	R372	297942	194818	R470	256540	66548
JF5	294894	64770	Q709	74168	206248	R1053	260553	189865	R2407	229870	143510	R373	251206	211328	R472	223266	227330
JF52	319532	194818	Q710	155702	232918	R1054	231648	147574	R2408	219202	180594	R374	271780	213614	R502	165862	107950
JF60	283616	29718	Q712	149352	231902	R1056	303784	163144	R2409	210058	157734	R375	269494	232410	R504	182626	111760
JF62	152908	185166	Q714	91186	231394	R1057	257810	184353	R241	300736	10160	R376	280416	142494	R505	190246	110744
JF68	214376	97282	Q715	81280	191008	R1060	233426	189230	R2410	200914	152146	R377	261873	233172	R506	190500	106172
JF69	236220	87884	Q717	90424	189992	R1061	218440	146304	R2411	202692	152146	R378	297434	199898	R507	193040	98552
JF7	302006	124206	Q801	201676	76200	R1802	138176	165862	R2412	204470	152146	R401	147320	26670	R509	159766	145542
JF70	237998	87884	Q802	234442	54356	R1803	141732	162560	R242	296672	10414	R402	159258	36322	R510	163068	124968
JF71	232664	87884	Q803	236474	59182	R1804	139954	165862	R243	287020	12446	R403	172974	30480	R511	163068	123190
JF74	246126	72390	Q804	218948	62484	R1805	143002	159512	R244	287020	14224	R404	182118	36576	R512	167132	110998
JF75	233248	179705	Q805	212344	62738	R1806	146558	184404	R245	291338	40386	R405	189992	33274	R513	157988	119634
JF76	304800	170815	Q901	134620	172212	R1807	139700	177800	R246	319278	56896	R406	186182	36576	R514	193294	128016
JF77	311150	172720	Q902	143764	165862	R1808	138430	170434	R247	310642	77470	R407	146812	14478	R515	175006	125476

MOTHER UNIT (F7240N7A) PWB COMPONENT LOCATION TABLES.

Copper Side.

Ref No	Xum	Yum	Ref No	Xum	Yum
R516	167894	107950	R732	81788	207264
R517	193040	100330	R733	75946	217932
R520	154940	75692	R735	72136	225806
R521	178308	72644	R736	75184	210566
R522	169164	53594	R737	61468	232664
R524	150622	65531	R738	67564	232664
R525	143510	61214	R739	75692	212852
R527	148590	71374	R740	83058	214884
R528	191516	119126	R743	122936	172466
R532	171704	77470	R744	97028	161036
R535	174244	120650	R745	87884	153670
R537	155956	79756	R746	87884	151892
R538	154178	79756	R747	129032	149098
R539	143510	115062	R748	118364	164338
R540	157226	102108	R749	83566	151892
R542	246380	87884	R750	94488	158750
R544	168402	123190	R751	144018	237744
R545	169164	113030	R752	158496	220472
R547	191262	116078	R754	145034	220726
R548	191516	128016	R755	145796	237744
R549	169164	114808	R758	148082	223012
R551	171196	118364	R762	71120	137922
R552	168656	56896	R765	100330	161036
R554	186436	142748	R766	99822	165608
R555	146050	69850	R767	93218	235966
R556	145542	65531	R768	70358	144780
R557	144272	69850	R769	58166	183134
R558	141986	65531	R774	72898	180848
R559	146812	73914	R775	81026	181102
R560	157734	79756	R776	92456	193294
R561	162560	110998	R777	77978	202184
R562	162560	109220	R787	71882	229362
R601	104140	100838	R788	86614	231648
R605	136906	100838	R789	86614	233426
R607	141986	103378	R801	204470	71882
R615	117094	12446	R802	228854	69850
R622	244094	87884	R803	223774	87884
R625	29972	80772	R804	225806	87884
R626	271145	178866	R805	229616	87884
R627	24384	79248	R806	240284	80264
R634	103378	94234	R807	244856	99568
R642	131318	107442	R808	217170	105156
R644	217932	169418	R809	203200	67310
R646	156464	58928	R810	198628	73152
R647	158496	63246	R811	231140	54356
R648	159512	61468	R812	243586	64516
R706	105410	145542	R813	240030	62484
R707	116332	169672	R816	211074	59690
R708	77978	206248	R817	214376	58674
R711	95250	203708	R818	207518	61722
R712	93980	206756	T702	56896	173228
R717	39370	129032			
R718	22606	106680			
R719	33274	142748			
R720	27432	135636			
R722	66802	150114			
R724	84963	157480			

PFC MODULE UNIT (F7336N2) PWB PARTS LOCATION TABLES.

Component side.

Copper side.

FYZBc	Li a	M a
(L6)	30226	66649
(PWA)	66294	68681
(PWB)	52070	68681
C1701	10668	57251
C1702	20066	51409
C1703	41402	51663
C1704	64008	22707
C1707	58928	59029
C1708	71882	42773
C1709	10414	34137
C2	59182	57505
D1703	61214	41503
FB1701	42418	13309
J12	48514	45567
Q1701	50292	22707
R1709	47752	33375
R1710	53086	44297
T1701	29972	33883

FYZBc	Li a	M a
C1705	54864	42265
C1706	48514	47599
D1701	27686	51409
D1702	25908	46837
IC1701	47752	42773
R1701	28194	55473
R1702	34798	55473
R1703	36322	50647
R1704	28194	59537
R1705	34798	59537
R1706	46482	53441
R1707	22352	51409
R1708	36068	45821
R1711	48514	49377
R1712	58674	43535
R1713	60452	39725
R1714	67056	41249
R1715	67056	47599

DIGITAL MODULE (F7313N0A) PWB PARTS LOCATION TABLES.

Component side.

Copper Side.

FYZBc	Li a	Ma
(KA)	115620	52527
(RGB)	138938	52527
C6014	148082	52578
C6016	147574	43434
C6021	104902	46228
C6023	136144	17780
C6027	18796	30734
C6030	18796	39624
C6034	31750	51562
C6035	13208	45212
C6065	36576	24130
C6069	11176	52832
C6079	88900	20574
C6083	148844	20320
IC6003	131063	33528
IC6005	7620	45212
Q6003	7620	36576
R6050	7620	31750
X1003	125222	16510
X6001	21336	51816
Y(A)	23495	8686
Y(B)	75768	8686
Y(C)	125730	8686

FYZBc	Li a	Ma
C6001	43180	45466
C6002	16764	45212
C6004	47244	39878
C6005	16764	43180
C6006	38100	46736
C6007	38100	44704
C6008	25400	34798
C6010	48260	35814
C6011	74930	48006
C6015	141732	45466
C6017	141986	41910
C6018	140462	48768
C6019	138684	48768
C6020	133350	48768
C6022	117856	36576
C6024	136144	19304
C6025	16764	47244
C6026	48260	33782
C6028	29464	30226
C6029	25400	38608
C6031	18796	49276
C6032	26416	49276
C6033	31750	50038
C6036	26162	44704
C6037	48260	31750
C6038	30734	21590
C6039	10414	22860
C6040	12192	22860
C6043	12192	18034
C6046	14478	22860
C6047	16256	22860
C6050	16256	18034
C6051	28702	21590
C6052	26670	21590
C6053	6350	22860
C6054	8128	22860
C6055	31242	14478
C6056	35306	14478
C6057	8128	18034
C6058	39370	14478
C6059	43688	14224
C6060	22606	22860
C6061	18542	22860
C6062	20320	22860
C6063	29210	14478
C6064	141986	31496
C6066	36576	30226
C6067	100838	15494
C6068	5334	40894
C6070	20320	18034
C6072	127508	19050
C6073	122936	19050
C6074	45720	17780
C6078	85090	20066
C6081	62992	24638
C6084	43434	32512
C6085	43434	29972
C6109	62992	20320
C6110	68834	24638
C6201	21082	5842
C6202	16002	5842
C6203	25908	5842
C6204	30988	5842
C6205	33528	5842
C6206	65786	5842

FYZBc	Li a	Ma
C6207	68326	5842
C6208	61214	6858
C6209	70866	5842
C6211	73406	5842
C6212	89408	5842
C6213	83312	5842
C6214	78232	5842
C6215	131572	48768
C6216	135128	48768
C6217	136906	48768
C6218	116586	5588
C6219	114554	5588
C6220	135890	5588
C6221	133350	5588
C6222	130809	5588
C6223	128270	5588
C6224	125730	5588
C6225	123190	5588
C6226	120650	5588
C6227	118618	5588
C6228	121920	49530
C6229	124460	49530
C6230	104648	54356
C6231	116840	49530
C6232	108204	55118
C6233	114554	49530
C6234	119380	49530
C6236	10922	5842
C6306	38608	5842
D6001	106172	15748
D6002	108712	19812
D6003	146304	18542
D6004	141986	20066
D6005	100076	19812
D6006	104140	9144
D6007	45720	20066
D6008	80264	22352
D6010	62738	22352
D6013	138684	34036
D6014	132588	34290
D6015	132588	36322
FB6205	104140	5334
FB6206	83312	12700
FB6207	97028	5334
FB6208	73152	13208
FB6210	118110	13208
FB6211	115062	13208
FB6212	112014	13208
IC6001	36322	37592
IC6002	82296	40640
IC6006	93218	20574
JF1	34290	37592
JF2	145288	34798
JF4	132588	36322
L6001	46228	50292
L6002	31496	54610
L6003	49784	43942
L6004	78232	48006
L6005	97790	48006
L6006	125730	40386
L6007	136144	23622
L6008	56642	5334
L6009	40132	51562
L6010	16510	34544
L6012	37338	19812

FYZBc	Li a	Ma
L6013	56642	8128
L6014	57404	10922
L6015	57404	13716
L6017	50038	50292
Q6008	91694	12954
Q6021	45974	23368
Q6022	56642	19558
Q6023	69088	19050
Q6024	74930	19050
Q6025	122428	36068
Q6026	132334	31242
Q6027	23368	14224
R6001	10414	18034
R6002	14478	18034
R6003	6350	18034
R6004	27178	14478
R6005	142240	48768
R6006	131572	51816
R6007	129794	48768
R6008	58166	47752
R6009	62230	46482
R6010	62230	43942
R6011	58166	45212
R6012	58166	35052
R6013	58166	42672
R6014	62230	41402
R6015	58166	40132
R6016	62230	38862
R6017	58166	37592
R6018	62230	36322
R6019	58166	33020
R6020	106934	43942
R6021	102870	42672
R6022	106934	41402
R6023	102870	40132
R6024	106934	38862
R6025	102870	37592
R6026	106934	36322
R6027	102870	35052
R6028	106934	33782
R6029	102870	32512
R6030	106934	31242
R6031	102870	29972
R6032	142748	38100
R6035	136144	21082
R6036	107442	13716
R6037	106680	19558
R6038	143002	23368
R6039	138938	14478
R6040	147320	30988
R6041	141986	33274
R6042	141986	29718
R6043	136652	38100
R6048	107442	11684
R6049	103886	19558
R6051	10414	40894
R6052	4064	47752
R6054	11176	52070
R6068	139700	6096
R6069	87884	12954
R6071	37338	14478
R6072	41402	14478
R6073	45720	14224
R6074	33274	14478
R6075	18542	18034

FYZBc	Li a	Ma
R6086	85090	18034
R6088	56642	24384
R6089	136652	34544
R6090	99060	22860
R6096	51308	20574
R6097	51308	18542
R6098	51308	22606
R6099	51308	24384
R6100	56642	22606
R6101	62992	18288
R6102	74930	22352
R6103	79502	24638
R6104	74930	24638
R6105	80264	20066
R6106	68834	22352
R6107	80264	18034
R6123	122682	31242
R6124	127508	35814
R6125	137414	29718
R6126	122682	33020
R6127	140970	23368
R6128	127508	33020
R6129	127508	31242
R6130	23368	11176
R6307	108966	7874

DESCRIPTION OF SCHEMATIC DIAGRAM

SAFETY NOTE:

1. DISCONNECT THE AC PLUG FROM THE AC OUTLET BEFORE REPLACING PARTS.
2. SEMICONDUCTOR HEAT SINKS SHOULD BE REGARDED AS POTENTIAL SHOCK HAZARDS WHEN THE CHASSIS IS OPERATING.

IMPORTANT SAFETY NOTE:

PARTS MARKED WITH « Δ » () ARE IMPORTANT FOR MAINTAINING THE SAFETY OF THE SET. BE SURE TO REPLACE THESE PARTS WITH SPECIFIED ONES FOR MAINTAINING THE SAFETY AND PERFORMANCE OF THE SET.

SERVICE PRECAUTION:

THE AREA ENCLOSED BY THIS LINE (---) IS DIRECTLY CONNECTED WITH AC MAINS VOLTAGE.
WHEN SERVICING THE AREA, CONNECT AN ISOLATING TRANSFORMER BETWEEN TV RECEIVER AND AC LINE TO ELIMINATE HAZARD OF ELECTRIC SHOCK.

NOTE:

1. The unit of resistance «ohm» is omitted (K=1000 ohms. M= Megaohm).
2. All resistors are 1/8 watt. unless otherwise noted.
3. All capacitors are mF, unless otherwise noted (P= mmF).
4. The capacitor with Part No. RC-FZ9XXXBMNJ is designed to with stand 63V.
5. The capacitor with Part No. RC-FZ4XXXBMNJ is designed to with stand 50V.

CAUTION

This circuit diagram is original one, therefore there may be light difference from yours.

WAVEFORM MEASUREMENT CONDITION:

Colour bar generator signal of 70 dB from RF input.

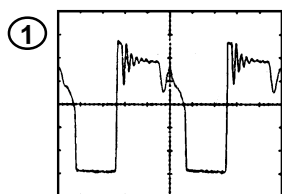

559Vpp

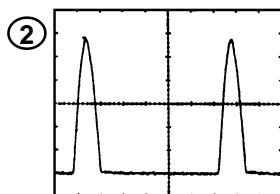

1.160Vpp 31,25KHz

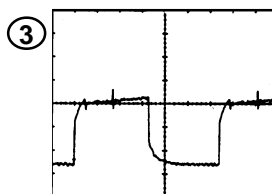

2,8Vpp 31,25KHz

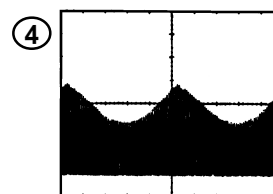

200 Vpp 100 Hz

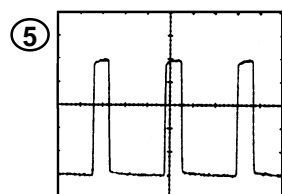

50Vpp 31,25KHz

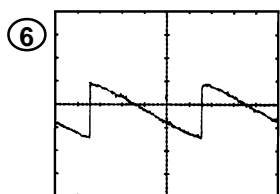

1,145 Vpp 100 Hz

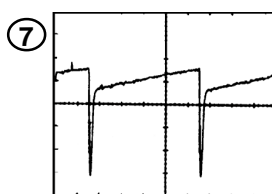

2,3V 100Hz

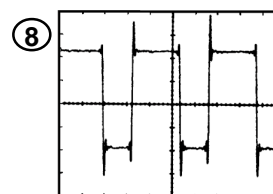

21 Vpp

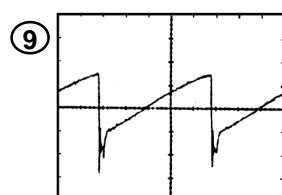

16,25Vpp 100Hz

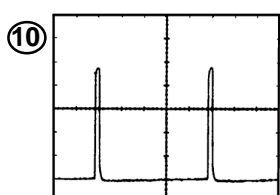

23,8 Vpp 100Hz

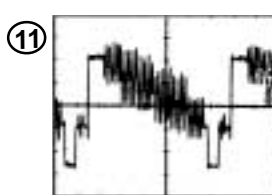

1 Vpp 15,625KHz

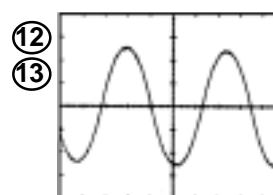

400Hz (Audio output)

SCHEMATIC DIAGRAM OF MOTHER UNIT (K7240N7), 01 Version.

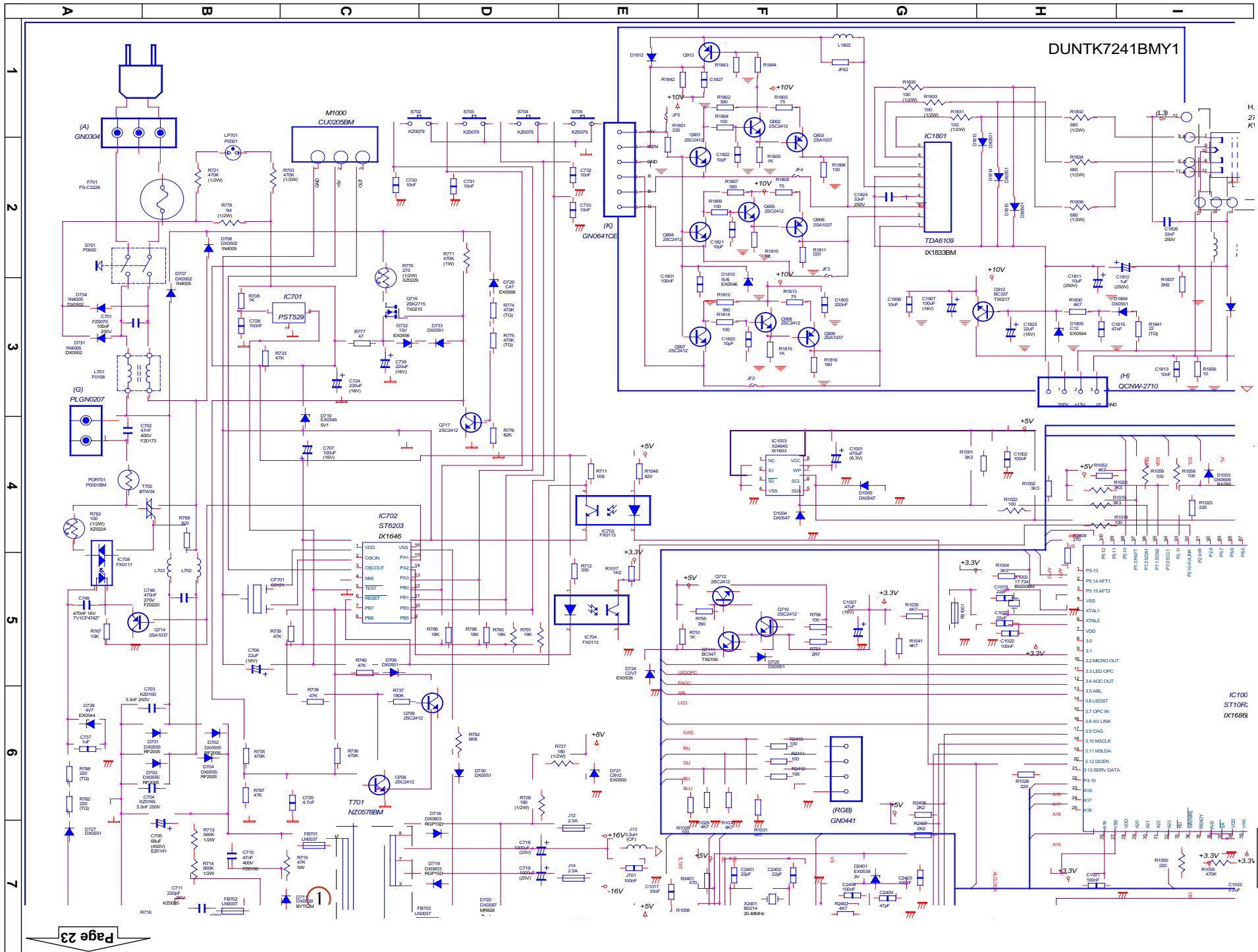

SCHEMATIC DIAGRAM OF MOTHER UNIT (K7240N7), 01 Version.

DUNTK7240BMX5

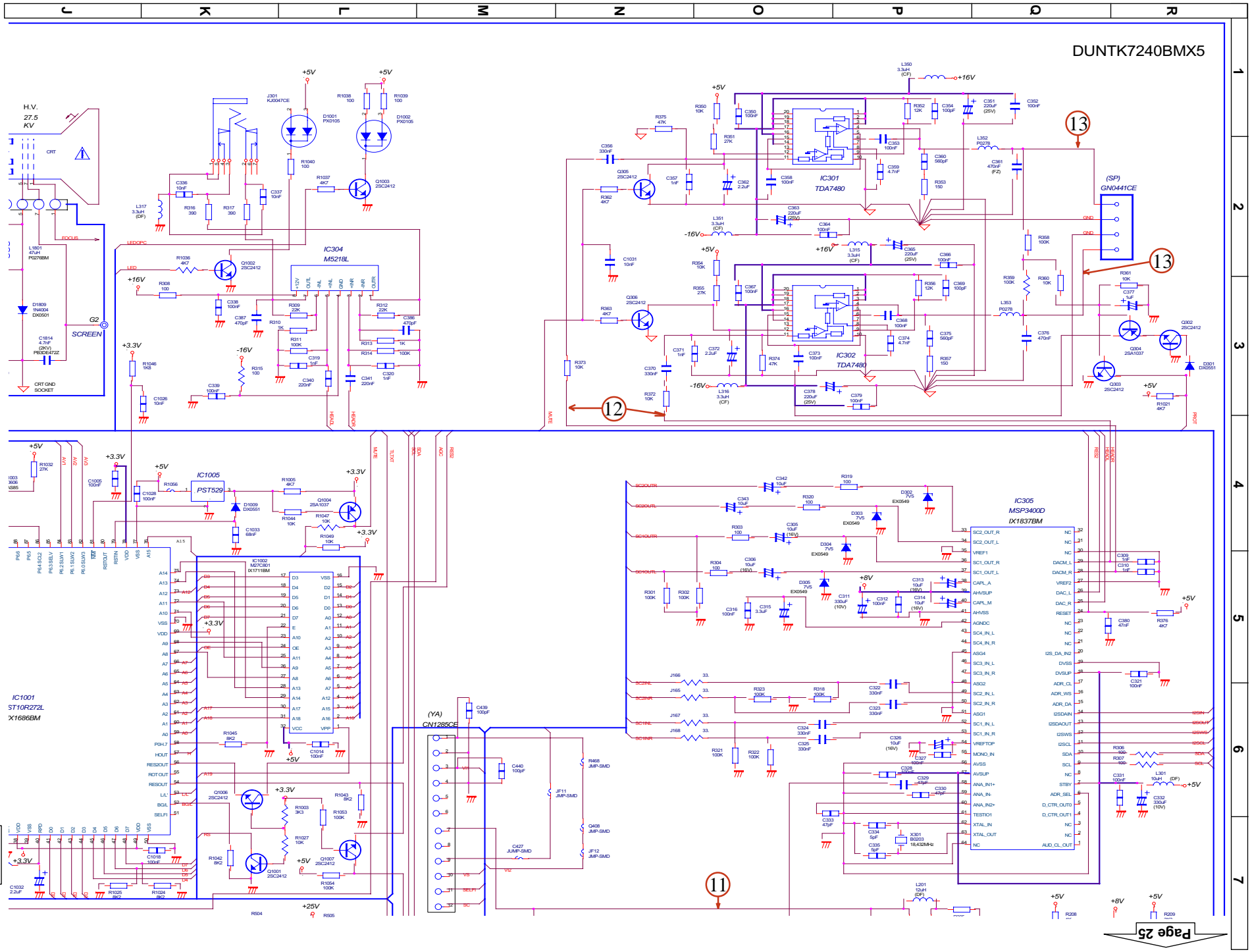

SCHEMATIC DIAGRAM OF DIGITAL MODULE UNIT (F7313NOA), 01 Version.

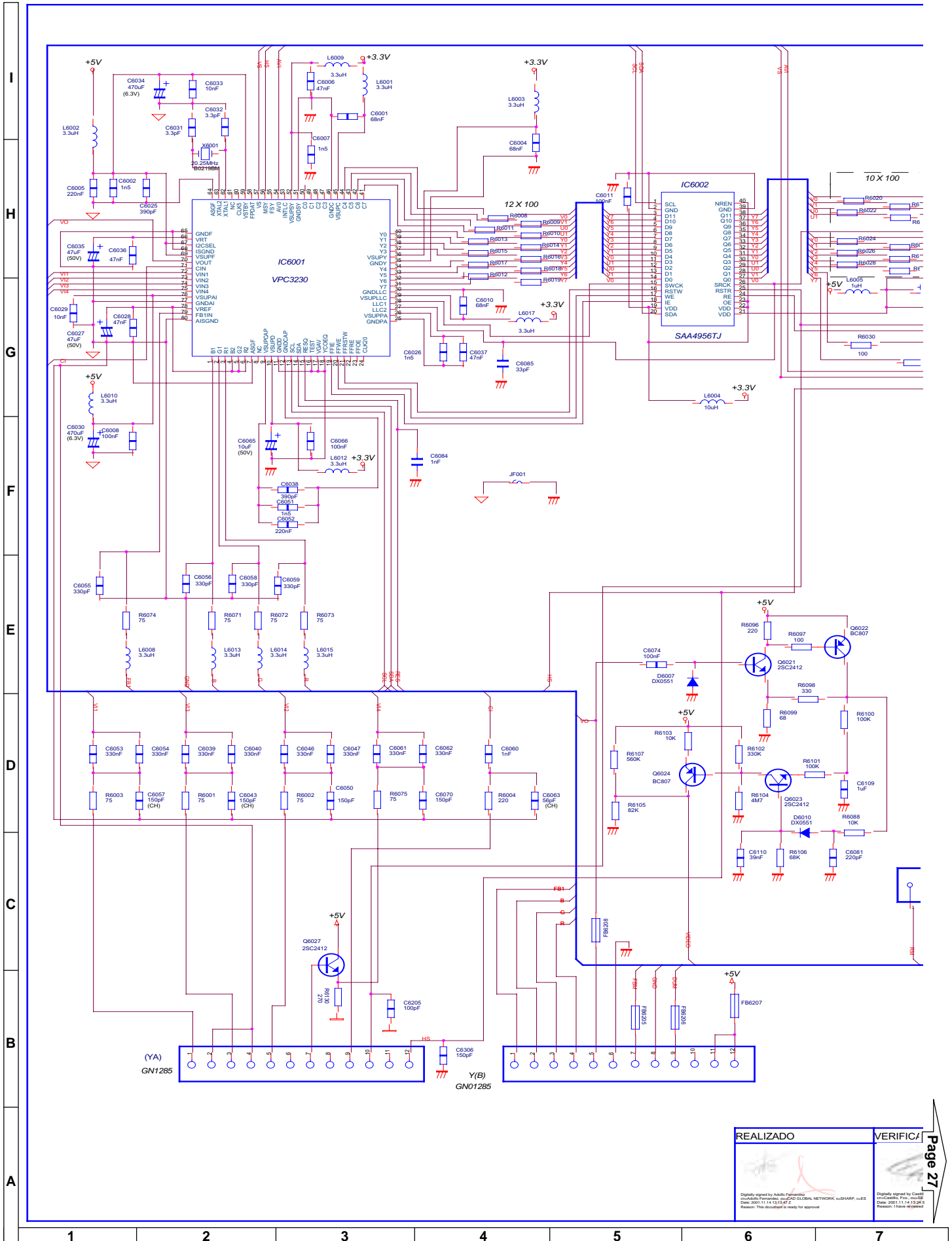

REALIZADO	VERIFICADO
<small>Digitally signed by Asiste Ferranandez DN: cn=Asiste Ferranandez, ou=CDI GLCBA NETWORK, c=ES Date: 2011.11.14 13:28:27</small>	<small>Digitally signed by Cesar DN: cn=Cesar, ou=CDI GLCBA NETWORK, c=ES Date: 2011.11.14 13:28:5 Reason: This document is ready for approval</small>

SCHEMATIC DIAGRAM OF DIGITAL MODULE UNIT (F7313NOA), 01 Version.

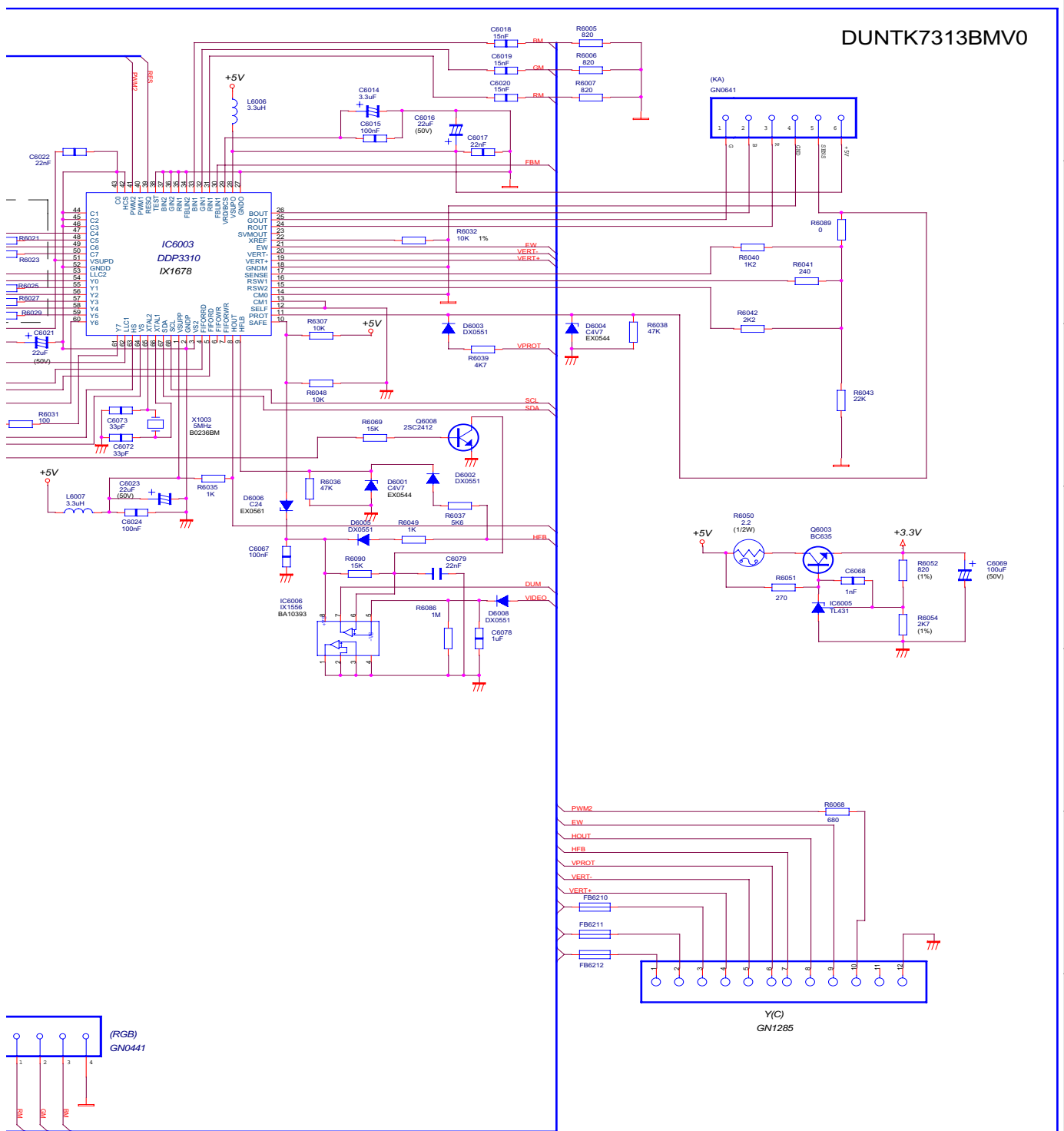

Page 26

APROBADO	APROBADO	NOMBRE	CODIGO	6	11-06-2001	HASTA INFO 1189	9
		MODULO DIGITAL	Q K I T P 7 3 1 3 B M N 0 A	5	13-02-2001	HASTA INFO 1046	8
FECHA	20-06-2001			4	12-01-2001	HASTA INFO 1012	7
MODELO	70GS64S			3	15-12-2000	HASTA INFO 989	6
				2	21-11-2000	HASTA INFO 948	5
				1	21-07-2000	HASTA INFO 776	4
					FECHA	REVISIONES	N

DUNTK7336BMV0

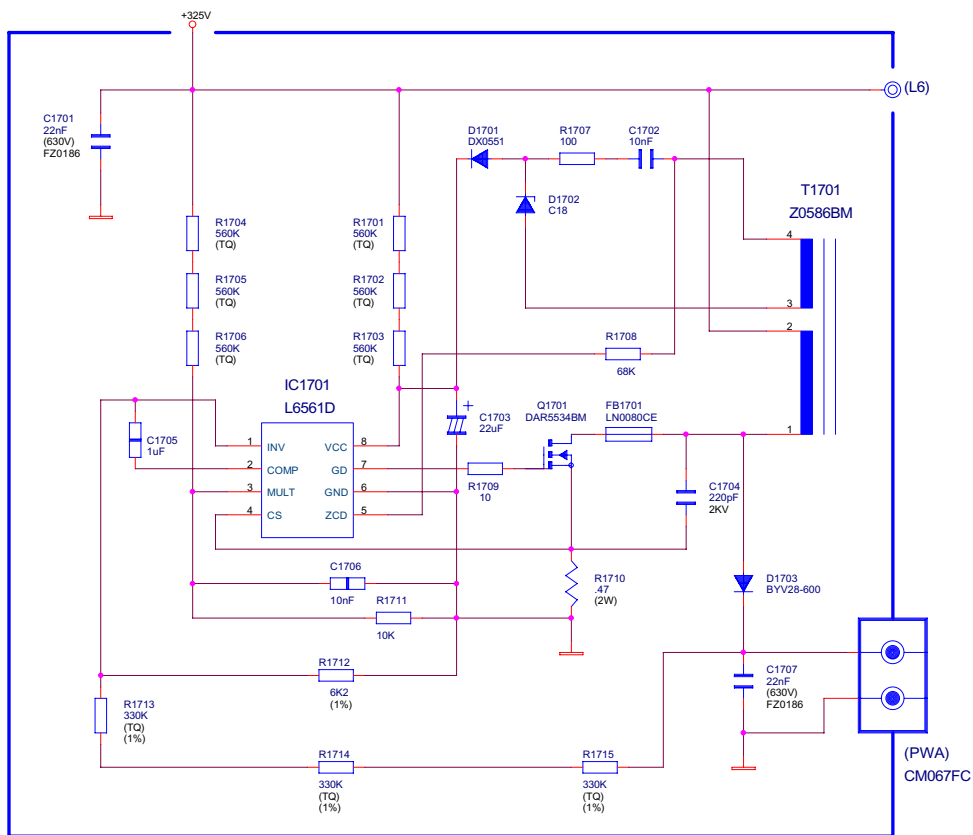

REALIZADO	VERIFICADO	APROBADO	NOMBRE	CODIGO	6	22-03-2001	HASTA INFO 1116	6	
			Modulo PFC	Q P W I B F 7 3 3 6 B I M N 2	5	14-03-2001	HASTA INFO 1103	5	
			FECHA 09-07-2001	SHARP ELECTRONICA ESPANA S.A.	ESCALA A-4	4	15-12-2000	HASTA INFO 991	4
			MODELO 70GS64S			3	15-12-2000	HASTA INFO 990	3
					2	22-11-2000	HASTA INFO 953	2	
					1	18-10-2000	HASTA INFO 879	1	
						FECHA	REVISIONES	N	

Digitally signed by Adolfo Fernandez:
 cn=Adolfo Fernandez, ou=CAD GLOBAL NETWORK, o=SHARP, ou=ES
 Date: 2001.11.14 13:14:52 Z
 Reason: This document is ready for approval

Digitally signed by Castillo, Fco.
 cn=Castillo, Fco., ou=SEES, ou=Engineering Dept., o=ES
 Date: 2001.11.14 13:25:44 Z
 Reason: I have reviewed this document

Digitally signed by Castillo, Fco.
 cn=Castillo, Fco., ou=SEES, ou=Engineering Dept., o=ES
 Date: 2001.11.14 13:26:21 Z
 Reason: I have reviewed this document

STEREO LED FLASHING CODES.

If the TV set does not work and the stereo led is flashing, follow the sequence according to the information below, as a guide to fault finding.

1. **Unable to read or write into NVM:** 66% ON, 33% OFF twice and OFF for a second.



2. **MSP failure:** 66% ON, 33% OFF for three times and OFF for a second.



3. **VPC failure:** 66% ON, 33% OFF for four times and OFF for a second.



4. **SAA4956 failure:** 66% ON, 33% OFF for six times and OFF for a second.

5. **DDP failure:** 66% ON, 33% OFF for seven times and OFF for a second.

BLOCK DIAGRAM .

70GS-64S BLOCK DIAGRAM

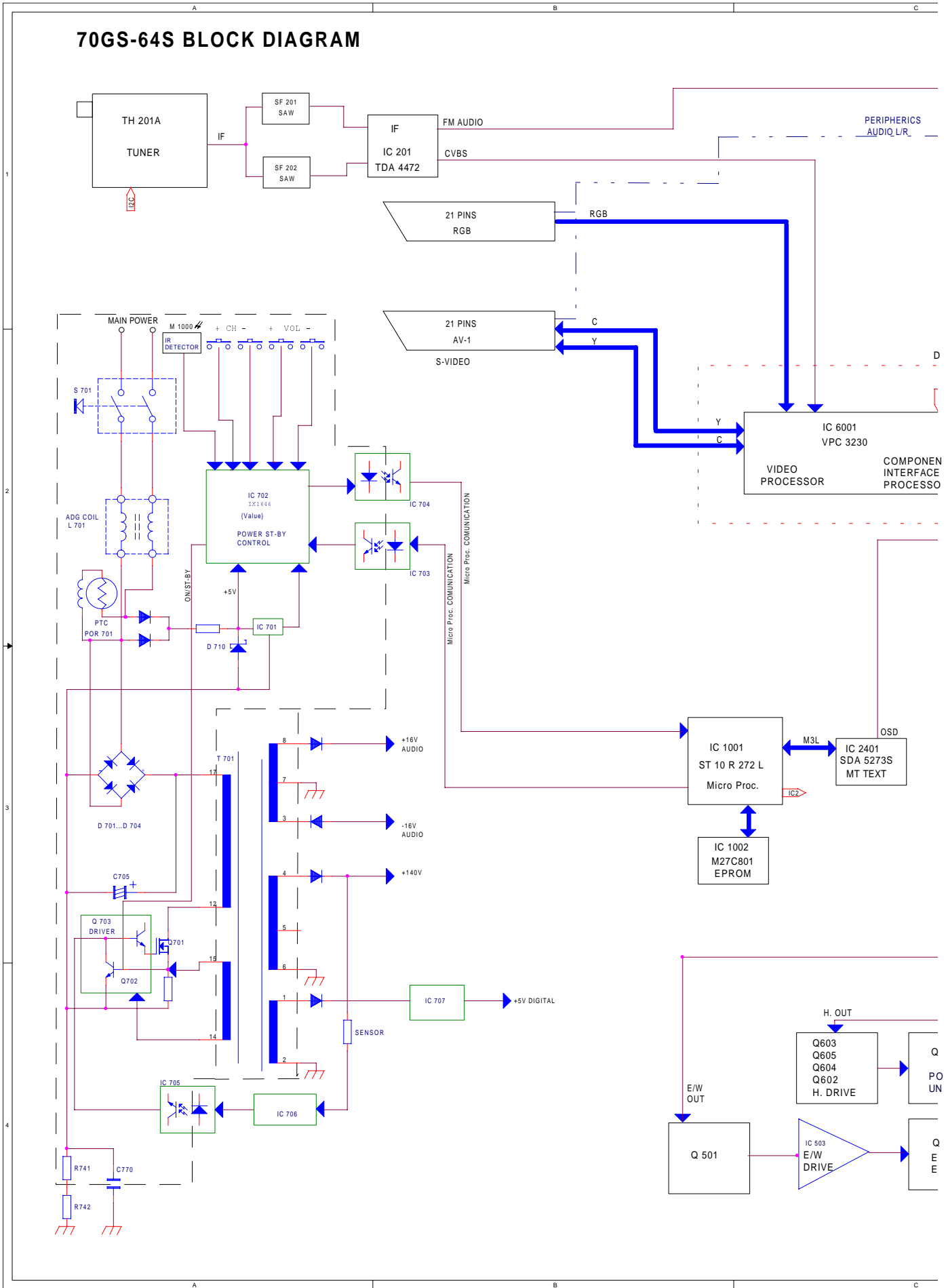

BLOCK DIAGRAM .

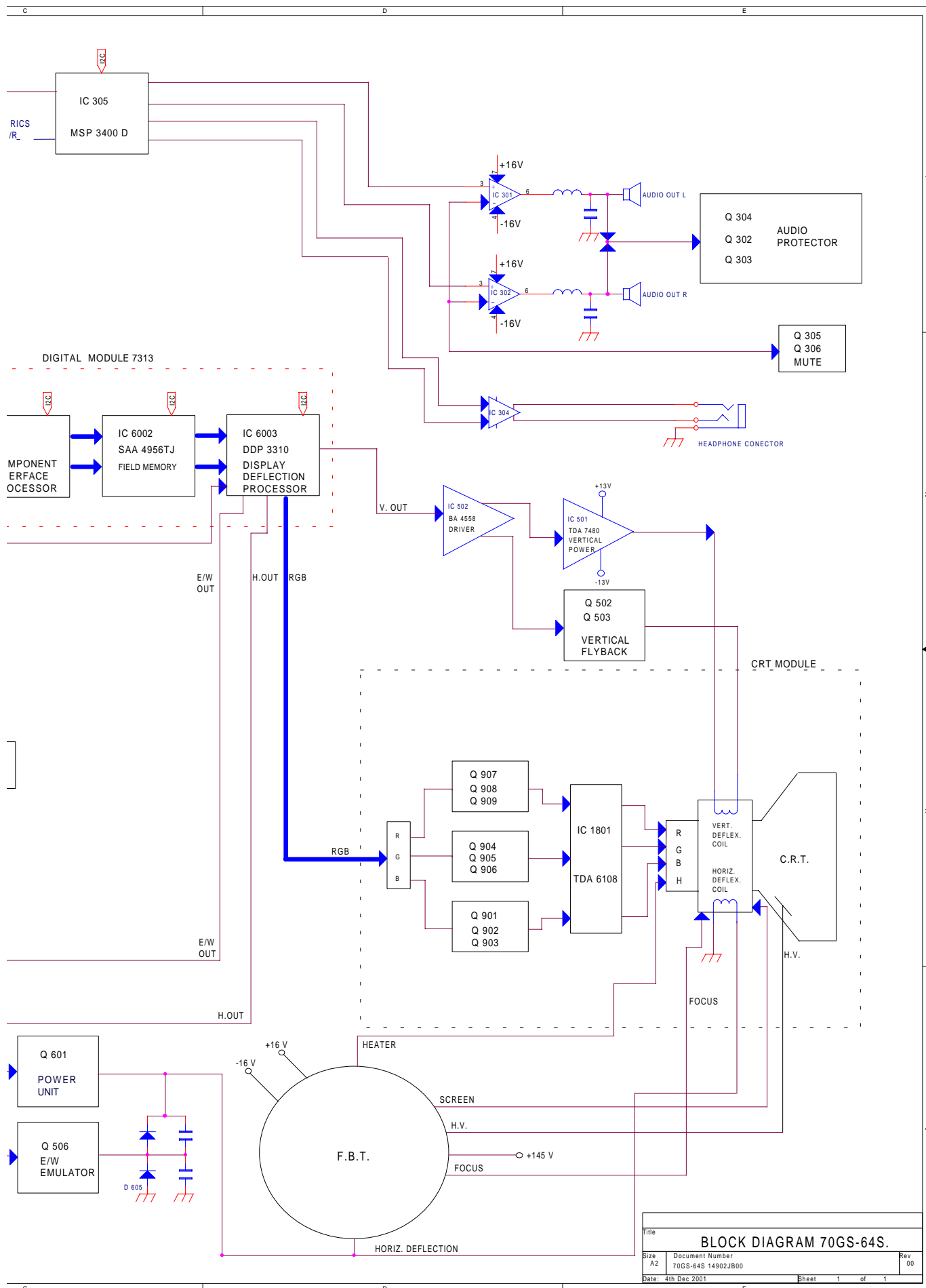

Page 30

Title		
BLOCK DIAGRAM 70GS-64S.		
Size	Document Number	Rev
A2	70GS-64S 14902JB00	00
Date:	4th Dec 2001	Sheet 1 of 1

PARTS LISTING

REPLACEMENT PARTS

Replacement parts which have special safety characteristics are identified in this manual. Electrical components having such features are identified by in the Replacement Part List.

The use of a substitute replacement part which does not have the same safety characteristics as the factory recommended is not permitted.

Replacement parts not shown in this service manual may create shock fire, or other hazards.

HOW TO ORDER REPLACEMENT PARTS

To have your order completed promptly and correctly please supply the following information.

1. MODEL NUMBER
2. REF. NO.
3. PART NO.
4. DESCRIPTION
5. CODE
6. QUANTITY

MARK *: SPARE PARTS DELIVERY SECTION

REF No.	PARTS	DESCRIPTION	* SN CODE	EX CODE
PICTURE TUBE (PHILIPS)				
△	VB66EAK0714*N	28" A66EAK071X44 100HZ PHIL BLACK 44% GT	S CQ	CU
△	CCILG0404BMV0	DEG COIL SET NUCTOR 28"	S AM	AV
PRINTED WIRING BOARDS (Not replacement item)				
PWB-A	DUNTK7240CJX5	MOTHER UNIT 70GS64S	S --	--
PWB-B	DUNTK7241BMY1	CRT UNIT DA100 AMPLI VIDEO PHILIPS	S --	--
PWB-C	DUNTK7313BMV0	DIGITAL MOD.RAM DINAMIC PHILIPS	S BF	BX
PWB-D	DUNTK7336BMV0	PCF MODULE	S AS	BD
PWB-A MOTHER UNIT				
TUNER				
TH 0201	RTUNH0123BMZZ	TUNER CTT5020 THOMSON	S AX	BA
INTEGRATED CIRCUITS				
IC 0201	RH-IX1672BMZZ	IC TDA4472-MFL TEMIC SMD	S AE	AP
IC 0202	RH-IX1556BMZZ	IC BA10393 S0P8 SMD ROHM	S AC	AD
IC 0203	RH-IX0037CEZ	IC UPC574J 33V NEC	S AF	AD
IC 0301	VHITDA7480/-1	IC TDA7480 THOMSON	S AF	AK
IC 0302	VHITDA7480/-1	IC TDA7480 THOMSON	S AF	AK
IC 0304	VHIM5218L/-1	IC M5218L	S AA	AD
IC 0305	RH-IX1837BMZZ	IC MSP3400D-PPCS MICRONAS	S AP	BA
IC 0501	RH-IX1786BMZZ	C.I. TDA 7480L THOMSON	S AD	AL
IC 0502	VHIBA4558F/-1	IC BA4558F-E2 ROHM OP-AMP	S AA	AC
IC 0503	RH-IX1556BMZZ	IC BA10393 S0P8 SMD ROHM	S AC	AD
IC 0701	VHIPST529C2-1	IC PST529C2 MITSUMI	S AD	AD
IC 0702	RH-IX1646BMZZ	IC ST6203B SMD SGS-THOMSON	S AF	AL
△ IC 0703	RH-FX0113BMZZ	OPTOCOUPLER TCET1 103G VISHAY	S AA	AC
△ IC 0704	RH-FX0113BMZZ	OPTOCOUPLER TCET1 103G VISHAY	S AA	AC
△ IC 0705	RH-FX0113BMZZ	OPTOCOUPLER TCET1 103G VISHAY	S AA	AC
IC 0706	RH-IX1674BMZZ	IC KA431AZ SAMSUNG	S AA	AD
IC 0707	RH-IX1704BMZZ	IC L4978 THOMSON	S AD	AK
IC 0708	RH-FX0111BMZZ	OPTOCOUPLER TLP165J TOSHIBA	S AB	AE
IC 1001	RH-IX1686BMZZ	IC ST10R272L THOMSON	S AK	AW
* IC 1002	CH-IX1841CJS2	EPROM SET AM 3V FLASH (S3-00x24 Soft. Vers. or next)	S AM	AY
IC 1003	RH-IX1603BMZZ	NVM X24645S8 XICOR SMD	S AS	AV
IC 1005	VHIPST529C2-1	IC PST529C2 MITSUMI	S AD	AD
IC 2401	RH-IX1673BMZZ	IC SDA5273-2 SIEMENS	S AT	BE
TRANSISTORS				
Q 0201	VS2SA1037KQ-1	TRT BC807 SMD	S AA	AA
Q 0209	VS2SC2412KQ-1	TRT 2SC2412 ROHM	S AA	AA
Q 0302	VS2SC2412KQ-1	TRT 2SC2412 ROHM	S AA	AA
Q 0303	VS2SC2412KQ-1	TRT 2SC2412 ROHM	S AA	AA
Q 0304	VS2SA1037KQ-1	TRT BC807 SMD	S AA	AA
Q 0305	VS2SC2412KQ-1	TRT 2SC2412 ROHM	S AA	AA
Q 0306	VS2SC2412KQ-1	TRT 2SC2412 ROHM	S AA	AA
Q 0403	VS2SC2412KQ-1	TRT 2SC2412 ROHM	S AA	AA
Q 0404	VS2SC2412KQ-1	TRT 2SC2412 ROHM	S AA	AA
Q 0405	VS2SA1037KQ-1	TRT BC807 SMD	S AA	AA
Q 0406	VS2SA1037KQ-1	TRT BC807 SMD	S AA	AA
Q 0501	VS2SC2412KQ-1	TRT 2SC2412 ROHM	S AA	AA
* NOTE: For 7240BMNF-NJ-NK PWB Version use the below IC1002. They are not interchangeable.				
IC 1002	CH-IX1711CJS0	EPROM OTP 4 MB THOMSON (S3-00x24 Soft. Vers. or next)	S AM	AY

REF No.	PARTS	DESCRIPTION	* SN CODE	EX CODE
Q 0502	RH-TX0201BMZZ	TRT KSA928A SAMGUNG	S AA	AC
Q 0503	RH-TX0239BMZZ	TRT SUD15N06-90L SILICONIX	S AA	AE
Q 0505	VS2SC2412KQ-1	TRT 2SC2412 ROHM	S AA	AA
Q 0506	RH-TX0151BMZZ	TRT 2SD2391Q SMD ROHM	S AC	AD
Q 0507	RH-TX0203BMZZ	TRT 2SB852 ROHM	S AA	AB
Q 0601	RH-TX0197BMZZ	TRT BU2525AX PHILIPS	S AG	AP
Q 0602	RH-TX0192BMZZ	TRT KSC2500 SAMSUNG	S AB	AC
Q 0603	VS2SC2412KQ-1	TRT 2SC2412 ROHM	S AA	AA
Q 0604	VS2SA1037KQ-1	TRT BC807 SMD	S AA	AA
Q 0605	RH-TX0192BMZZ	TRT KSC2500 SAMSUNG	S AB	AC
Q 0606	VS2SC2412KQ-1	TRT 2SC2412 ROHM	S AA	AA
Q 0701	RH-TX0198BMZZ	TRT S5F10N80A SAMSUNG	S AM	AU
Q 0702	RH-TX0182BMZZ	TRT 2PD602AR PHILIPS	S AA	AB
Q 0703	RH-TX0151BMZZ	TRT 2SD2391Q SMD ROHM	S AC	AD
Q 0708	VS2SC2412KQ-1	TRT 2SC2412 ROHM	S AA	AA
Q 0709	VS2SC2412KQ-1	TRT 2SC2412 ROHM	S AA	AA
Q 0710	VS2SC2412KQ-1	TRT 2SC2412 ROHM	S AA	AA
Q 0711	RH-TX0106BMZZ	TRT BC547	S AA	AB
Q 0714	VS2SA1037KQ-1	TRT BC807 SMD	S AA	AA
Q 0715	RH-TX0215BMZZ	MOSFET 2SK2715 ROHM	S AA	AE
Q 0717	VS2SC2412KQ-1	TRT 2SC2412 ROHM	S AA	AA
Q 0718	RH-TX0118BMZZ	TRT BC635-16 BETA > 100	S AC	AC
Q 1001	VS2SC2412KQ-1	TRT 2SC2412 ROHM	S AA	AA
Q 1002	VS2SC2412KQ-1	TRT 2SC2412 ROHM	S AA	AA
Q 1003	VS2SC2412KQ-1	TRT 2SC2412 ROHM	S AA	AA
Q 1004	VS2SA1037KQ-1	TRT BC807 SMD	S AA	AA
Q 1006	VS2SC2412KQ-1	TRT 2SC2412 ROHM	S AA	AA
Q 1007	VS2SC2412KQ-1	TRT 2SC2412 ROHM	S AA	AA
Q 2401	VS2SC2412KQ-1	TRT 2SC2412 ROHM	S AA	AA
DIODES				
D 0204	RH-DX0548BMZZ	DIODE VARICAP BBY40	S AC	AE
D 0301	RH-DX0551BMZZ	DIODE LL4148 TFK SMD	S AA	AA
D 0302	RH-EX0549BMZZ	ZENER DIODE TZMC7V5 TFK SMD	S AA	AA
D 0303	RH-EX0549BMZZ	ZENER DIODE TZMC7V5 TFK SMD	S AA	AA
D 0304	RH-EX0549BMZZ	ZENER DIODE TZMC7V5 TFK SMD	S AA	AA
D 0305	RH-EX0549BMZZ	ZENER DIODE TZMC7V5 TFK SMD	S AA	AA
D 0403	RH-EX0549BMZZ	ZENER DIODE TZMC7V5 TFK SMD	S AA	AA
D 0404	RH-EX0549BMZZ	ZENER DIODE TZMC7V5 TFK SMD	S AA	AA
D 0405	RH-EX0549BMZZ	ZENER DIODE TZMC7V5 TFK SMD	S AA	AA
D 0406	RH-EX0549BMZZ	ZENER DIODE TZMC7V5 TFK SMD	S AA	AA
D 0407	RH-EX0549BMZZ	ZENER DIODE TZMC7V5 TFK SMD	S AA	AA
D 0408	RH-EX0549BMZZ	ZENER DIODE TZMC7V5 TFK SMD	S AA	AA
D 0409	RH-EX0549BMZZ	ZENER DIODE TZMC7V5 TFK SMD	S AA	AA
D 0410	RH-EX0549BMZZ	ZENER DIODE TZMC7V5 TFK SMD	S AA	AA
D 0411	RH-EX0546BMZZ	ZENER DIODE TZMC5V6 TFK SMD	S AA	AA
D 0412	RH-DX0551BMZZ	DIODE LL4148 TFK SMD	S AA	AA
D 0413	RH-EX0584BMZZ	ZENER DIODE TZMB6V2 TFK SMD 2%	S AA	AA
D 0414	RH-DX0551BMZZ	DIODE LL4148 TFK SMD	S AA	AA
D 0416	RH-EX0547BMZZ	ZENER DIODE TZMC6V2 TFK SMD	S AA	AA
D 0417	RH-EX0547BMZZ	ZENER DIODE TZMC6V2 TFK SMD	S AA	AA
D 0420	RH-EX0546BMZZ	ZENER DIODE TZMC5V6 TFK SMD	S AA	AA
D 0421	RH-EX0544BMZZ	ZENER DIODE TZMC4V7 TFK SMD	S AA	AA
D 0502	RH-DX0551BMZZ	DIODE LL4148 TFK SMD	S AA	AA
D 0503	RH-DX0551BMZZ	DIODE LL4148 TFK SMD	S AA	AA
D 0504	RH-DX0551BMZZ	DIODE LL4148 TFK SMD	S AA	AA
D 0506	RH-DX0551BMZZ	DIODE LL4148 TFK SMD	S AA	AA
D 0605	RH-DX0585BMZZ	DIODE DMV32AF5 THOMSON	S AH	AM
D 0507	RH-EX0554BMZZ	ZENER DIODE TZMC12 TFK SMD	S AA	AA
D 0508	RH-DX0551BMZZ	DIODE LL4148 TFK SMD	S AA	AA
D 0509	RH-DX0551BMZZ	DIODE LL4148 TFK SMD	S AA	AA
D 0510	RH-DX0505BMZZ	DIODE 1N4935	S AB	AE
D 0515	RH-EX0544BMZZ	ZENER DIODE TZMC4V7 TFK SMD	S AA	AA
D 0616	RH-EX0837BMZZ	ZENER DIODE BZT03C47 PHILIPS	S AA	AD
D 0601	RH-DX0551BMZZ	DIODE LL4148 TFK SMD	S AA	AA
D 0606	RH-DX0505BMZZ	DIODE 1N4935	S AB	AE
D 0608	RH-DX0505BMZZ	DIODE 1N4935	S AB	AE
D 0609	RH-DX0505BMZZ	DIODE 1N4935	S AB	AE
D 0610	RH-DX0519BMZZ	DIODE 1N5819 MOROROLA	S AB	AD
D 0611	RH-DX0519BMZZ	DIODE 1N5819 MOROROLA	S AB	AD
D 0612	RH-DX0519BMZZ	DIODE 1N5819 MOROROLA	S AB	AD
D 0613	RH-DX0506BMZZ	DIODE 1N4936	S AB	AB
D 0614	RH-DX0551BMZZ	DIODE LL4148 TFK SMD	S AA	AA
D 0619	RH-DX0551BMZZ	DIODE LL4148 TFK SMD	S AA	AA

REF No.	PARTS	DESCRIPTION	* SN CODE	EX CODE	REF No.	PARTS	DESCRIPTION	* SN CODE	EX CODE
D 0620	RH-DX0551BMZZ	DIODE LL4148 TFK SMD	S AA	AA	L 0701	RCILF0108BMZZ	COIL 472839.00 THOMSON	S AF	AL
D 0621	RH-DX0506BMZZ	DIODE 1N4936	S AB	AB	L 0702	RCILP0110CEZZ	COIL 3.3uH TDK	S AD	AD
D 0623	RH-EX0421BMZZ	ZENER DIODE BZX79C18V	S AA	AA	L 0703	RCILP0110CEZZ	COIL 3.3uH TDK	S AD	AD
D 0701	RH-DX0555BMZZ	DIODE RF2005 FAGOR	S AA	AB	L 0705	RCILP0285BMZZ	COIL PCV1620-500K DIONIX	S AB	AF
D 0702	RH-DX0555BMZZ	DIODE RF2005 FAGOR	S AA	AB	L 2401	VP-DF3R3K0000	PEAK COIL 3.3UH 10%	S AB	AB
D 0703	RH-DX0555BMZZ	DIODE RF2005 FAGOR	S AA	AB	L 2402	VP-DF100K0000	PEAK COIL 10UH 10%	S AA	AA
D 0704	RH-DX0555BMZZ	DIODE RF2005 FAGOR	S AA	AB			CERAMIC FILTERS		
D 0706	RH-DX0551BMZZ	DIODE LL4148 TFK SMD	S AA	AA	CF 0202	RFILC0020CEZZ	FILTER SIF TRAP (TAPED)	S AE	AE
D 0707	RH-DX0502BMZZ	DIODE 1N4005	S AB	AA	CF 0701	RFILC0121GEZZ	FILTER CST8.00MTW MURATA	S AC	AD
D 0708	RH-DX0502BMZZ	DIODE 1N4005	S AB	AA	SF 0201	RFILC0274BMZZ	SAW FILTER G1984 SIEMENS	S AF	AK
D 0710	RH-EX0545BMZZ	ZENER DIODE TZMC5V1 TFK SMD	S AA	AA	SF 0202	RFILC0286BMZZ	FILTER K9356M SIEMENS	S AC	AG
D 0711	RH-DX0539BMZZ	DIODE BYT52M TFK	S AA	AC			TRANSFORMERS		
D 0712	RH-EX0419BMZZ	ZENER DIODE BZX79C15V 0.4W	S AA	AB	△ T 0601	RTRNF2041BMZZ	FBT 28" 47320224 OREGA	S AZ	BB
D 0713	RH-DX0551BMZZ	DIODE LL4148 TFK SMD	S AA	AA	△ T 0701	RTRNZ0578BMZZ	CHOPPER TG-0601A DIEMEN	S AF	AT
D 0714	RH-DX0605BMZZ	DIODE MBR340RL MOTOROLA	S AA	AE			CAPACITORS		
D 0715	RH-DX0551BMZZ	DIODE LL4148 TFK SMD	S AA	AA	C 0204	VCEAGA1HW225M	ELEC C 2.2UF 20% 50V	S AA	AB
D 0716	RH-EX0411BMZZ	ZENER DIODE BZX79C6V8	S AA	AA	C 0205	RC-FZ4474BMNJ	POL FILM C 470nF 50V 5% ECQ-V PANASONIC	S AA	AC
D 0718	RH-DX0603BMZZ	DIODE RGP15D FAGOR	S AA	AC	C 0206	VCEAGA1HW225M	ELEC C 2.2UF 20% 50V	S AA	AB
D 0719	RH-DX0603BMZZ	DIODE RGP15D FAGOR	S AA	AC	C 0207	VCKYTV1HF103Z	CERAM C 10NF 50V 2125SMD	S AA	AA
D 0720	RH-DX0587BMZZ	DIODE MR826 PREFORM C6.3	S AH	AP	C 0208	VCKYTV1HF23Z	CERAM C 22NF 50V 2125SMD	S AA	AA
D 0721	RH-EX0506BMZZ	ZENER DIODE TZMC8V2 TFK SMD	S AA	AA	C 0209	VCEAGA1CW107M	ELEC C 100UF 20% 16V	S AA	AA
D 0722	RH-DX0603BMZZ	DIODE RGP15D FAGOR	S AA	AC	C 0211	VCEAGA1HW106M	ELEC C 10UF 20% 50V	S AA	AA
D 0724	RH-EX0538BMZZ	ZENER DIODE TZMC2V7 TFK SMD	S AA	AA	C 0212	VRS-TV1JD000J	2125 0 OHM 5% 1/10W SMD	S AA	AA
D 0725	RH-DX0551BMZZ	DIODE LL4148 TFK SMD	S AA	AA	C 0213	VRS-TV1JD000J	2125 0 OHM 5% 1/10W SMD	S AA	AA
D 0726	RH-EX0554BMZZ	ZENER DIODE TZMC12 TFK SMD	S AA	AA	C 0214	VCKYTV1HF103Z	CERAM C 10NF 50V 2125SMD	S AA	AA
D 0727	RH-DX0551BMZZ	DIODE LL4148 TFK SMD	S AA	AA	C 0215	VCEAGA1AW477M	ELEC C 470UF 20% 10V	S AA	AB
D 0728	RH-EX0544BMZZ	ZENER DIODE TZMC4V7 TFK SMD	S AA	AA	C 0216	VCCCTV1HH270J	CERAM C 27PF 50V 2125SMD	S AA	AA
D 0729	RH-EX0568BMZZ	ZENER DIODE TZMC47 TFK SMD	S AA	AA	C 0217	VCCCTV1HH221J	CERAM C 220PF 50V 2125SMD	S AA	AA
D 0730	RH-DX0551BMZZ	DIODE LL4148 TFK SMD	S AA	AA	C 0218	VCEAGA1CW226M	ELEC C 22UF 20% 16V	S AA	AA
D 0731	RH-DX0502BMZZ	DIODE 1N4005	S AB	AA	C 0219	VCEAGA1HW105M	ELEC C 1UF 20% 50V	S AA	AA
D 0732	RH-EX0568BMZZ	ZENER DIODE TZMC15 TFK SMD	S AA	AA	C 0220	VCEAGA1HW105M	ELEC C 1UF 20% 50V	S AA	AA
D 0733	RH-DX0551BMZZ	DIODE LL4148 TFK SMD	S AA	AA	C 0221	VCCCTV1HH220J	CERAM C 22PF 50V 2125SMD	S AA	AA
D 0734	RH-DX0502BMZZ	DIODE 1N4005	S AB	AA	C 0222	VCCCTV1HH220J	CERAM C 22PF 50V 2125SMD	S AA	AA
D 0735	RH-EX0875BMZZ	DIODE BZ0W4-145=170V FAGOR	S AA	AD	C 0223	VCKYTV1HF333Z	CERAM C 33NF 50V 2125SMD	S AA	AA
D 1001	RH-PX0105BMZZ	LED SPB-25MVW ROHM	S AC	AC	C 0224	VCKYTV1HB103K	CERAM C 10NF 50V 2125SMD	S AA	AA
D 1002	RH-PX0105BMZZ	LED SPB-25MVW ROHM	S AC	AC	C 0225	VCKYTV1HB103K	CERAM C 10NF 50V 2125SMD	S AA	AA
D 1003	RH-DX0606BMZZ	DIODE BAS85 PHILIPS SMD	S AA	AB	C 0228	VCCWPA2HL8R2C	C 8.2PF 0.25 N1500 500V	S AA	AB
D 1007	RH-EX0546BMZZ	ZENER DIODE TZMC5V6 TFK SMD	S AA	AA	C 0305	VCEAGA1CW106M	ELEC C 10UF 20% 16V	S AA	AA
D 1008	RH-EX0546BMZZ	ZENER DIODE TZMC5V6 TFK SMD	S AA	AA	C 0306	VCEAGA1CW106M	ELEC C 10UF 20% 16V	S AA	AA
D 1009	RH-DX0551BMZZ	DIODE LL4148 TFK SMD	S AA	AA	C 0309	VCKYTV1HB102K	CERAM C 1NF 50V 2125SMD	S AA	AA
D 2401	RH-EX0539BMZZ	ZENER DIODE TZMC3V0 TFK SMD	S AA	AA	C 0311	VCEAGA1AW337M	ELEC C 330UF 20% 10V	S AA	AA
		PACKAGED CIRCUITS			C 0312	VCKYTV1HF104Z	CERAM C 100NF 50V 2125SMD	S AA	AA
POR0701	RMPTP0001BMZZ	PTC B59250-C1080-B70	S AA	AD	C 0313	VCEAGA1CW106M	ELEC C 10UF 20% 16V	S AA	AA
X 0301	RCRSB0203BMZZ	CRYSTAL 18.432 MHZ	S AD	AG	C 0314	VCEAGA1CW106M	ELEC C 10UF 20% 16V	S AA	AA
X 1002	RCRSB0200BMZZ	CRYSTAL 17.734 MHZ	S AD	AG	C 0315	VCEAGA1HW335M	ELEC C 3.3UF 20% 50V	S AA	AA
X 2401	RCRSB0214BMZZ	CRYSTAL 20.48 MHZ SEL	S AD	AH	C 0316	VCKYTV1HF104Z	CERAM C 100NF 50V 2125SMD	S AA	AA
		COILS			C 0319	VCKYTV1HB102K	CERAM C 1NF 50V 2125SMD	S AA	AA
L 0002	QTIPM0017CEFM	TIP	S AA	AA	C 0320	VCKYTV1HB102K	CERAM C 1NF 50V 2125SMD	S AA	AA
L 0006	QTIPM0017CEFM	TIP	S AA	AA	C 0321	VCKYTV1HF104Z	CERAM C 100NF 50V 2125SMD	S AA	AA
L 0201	VP-DF120K0000	PEAK COIL 12UH 10%	S AA	AA	C 0322	VCKYTV1HF104Z	CERAM C 100NF 50V 2125SMD	S AA	AA
L 0202	VP-NM150KR63N	COIL 15UH SMD	S AB	AC	C 0323	RC-FZ4334BMNJ	POL FILM C 330nF 50V 5% ECQ-V PANASONIC	S AA	AB
L 0203	VP-CF6R8K0000	PEAK COIL 6.8UH 10%	S AA	AA	C 0324	RC-FZ4334BMNJ	POL FILM C 330nF 50V 5% ECQ-V PANASONIC	S AA	AB
L 0204	RCILP0229BMZZ	COIL SMD 610NH LQN1HR61J	S AA	AD	C 0325	RC-FZ4334BMNJ	POL FILM C 330nF 50V 5% ECQ-V PANASONIC	S AA	AB
L 0205	VP-NM1R0MR10N	COIL 1UH SMD	S AB	AB	C 0326	VCEAGA1CW106M	ELEC C 10UF 20% 16V	S AA	AA
L 0301	VP-DF100K0000	PEAK COIL 10UH 10%	S AA	AA	C 0327	VCKYTV1HF104Z	CERAM C 100NF 50V 2125SMD	S AA	AA
L 0315	VP-CF3R3K0000	PEAK COIL 3.3UH 10%	S AB	AB	C 0328	VCKYTV1HF104Z	CERAM C 100NF 50V 2125SMD	S AA	AA
L 0316	VP-CF3R3K0000	PEAK COIL 3.3UH 10%	S AB	AB	C 0329	VCCCPA1HH470J	CERAM C 47PF 5% 50V	S AA	AA
L 0317	VP-DF3R3K0000	PEAK COIL 3.3UH 10%	S AB	AB	C 0330	VCCCTV1HH470J	CERAM C 47PF 50V 2125SMD	S AA	AA
L 0350	VP-CF3R3K0000	PEAK COIL 3.3UH 10%	S AB	AB	C 0331	VCKYTV1HF104Z	CERAM C 100NF 50V 2125SMD	S AA	AA
L 0351	VP-CF3R3K0000	PEAK COIL 3.3UH 10%	S AB	AB	C 0332	VCEAGA1AW337M	ELEC C 330UF 20% 10V	S AA	AA
L 0352	RCILP0278BMZZ	COIL A823LY-680K TOKO	S AA	AD	C 0333	VCCCTV1HH470J	CERAM C 47PF 50V 2125SMD	S AA	AA
L 0353	RCILP0278BMZZ	COIL A823LY-680K TOKO	S AA	AD	C 0334	VCCCTV1HH5R0C	CERAM C 5PF 50V 2125SMD	S AA	AA
L 0501	RCILP0271BMZZ	COIL BC-400K DIEMEN	S AD	AG	C 0335	VCCCTV1HH5R0C	CERAM C 5PF 50V 2125SMD	S AA	AA
L 0502	VP-CF3R3K0000	PEAK COIL 3.3UH 10%	S AB	AB	C 0336	VCKYTV1HF103Z	CERAM C 10NF 50V 2125SMD	S AA	AA
L 0503	VP-CF3R3K0000	PEAK COIL 3.3UH 10%	S AB	AB	C 0337	VCKYTV1HF103Z	CERAM C 10NF 50V 2125SMD	S AA	AA
L 0601	VP-NM3R3MR19N	COIL 3.3UH SMD	S AA	AC	C 0338	VCKYTV1HF104Z	CERAM C 100NF 50V 2125SMD	S AA	AA
L 0603	RCILP0262BMZZ	COIL HR18008.00 DIEMEN	S AD	AG	C 0339	VCKYTV1HF104Z	CERAM C 100NF 50V 2125SMD	S AA	AA
L 0604	RCILP0263BMZZ	COIL HR18009.00 DIEMEN	S AD	AG	C 0340	VCKYTV1EF224Z	CERAM C 220NF 25V 2125SMD	S AA	AA
L 0605	RCIL20718BMZZ	COIL HR13042-00 DIEMEN	S AL	AD	C 0341	RC-FZ4224BMNJ	POL FILM C 220nF 50V 5% ECQ-V PANASONIC	S AA	AC
L 0609	RCILP0265BMZZ	COIL AR621LY-1R5M=R TOKO	S AC	AD	C 0342	VCEAGA1HW106M	ELEC C 10UF 20% 50V	S AA	AA
L 0611	VP-CF220K0000	PEAK COIL 22UH 10%	S AA	AA					
L 0612	VP-CF220K0000	PEAK COIL 22UH 10%	S AA	AA					

REF No.	PARTS	DESCRIPTION	* SN CODE	EX CODE
C 0343	VCEAGA1HW106M	ELEC C 100UF 20% 50V	S AA	AA
C 0350	VCKYTV1HF104Z	CERAM C 100NF 50V 2125SMD	S AA	AA
C 0351	VCEAGA1EW227M	ELEC C 220UF 20% 25V	S AA	AA
C 0352	RC-FZ4104BMNJ	POL FILM C 100nF 50V 5% ECQ-V PANASONIC	S AA	AB
C 0353	RC-FZ4104BMNJ	POL FILM C 100nF 50V 5% ECQ-V PANASONIC	S AA	AB
C 0354	VCCCTV1HH101J	CERAM C 100PF 50V 2125SMD	S AA	AA
C 0356	RC-FZ4334BMNJ	POL FILM C 330nF 50V 5% ECQ-V PANASONIC	S AA	AB
C 0357	VCKYTV1HB102K	CERAM C 1NF 50V 2125SMD	S AA	AA
C 0358	RC-FZ4104BMNJ	POL FILM C 100nF 50V 5% ECQ-V PANASONIC	S AA	AB
C 0359	VCKYTV1HB472K	CERAM C 4,7NF 50V 2125SMD	S AA	AA
C 0360	VCCCTV1HH561J	CERAM C 560PF 50V 2125SMD	S AA	AA
C 0361	RC-FZ4474BMNJ	POL FILM C 470nF 50V 5% ECQ-V PANASONIC	S AA	AC
C 0362	VCEAGA1HW225M	ELEC C 2,2UF 20% 50V	S AA	AB
C 0363	VCEAGA1EW227M	ELEC C 220UF 20% 25V	S AA	AA
C 0364	VCKYTV1HF104Z	CERAM C 100NF 50V 2125SMD	S AA	AA
C 0365	VCEAGA1EW227M	ELEC C 220UF 20% 25V	S AA	AA
C 0366	VCKYTV1HF104Z	CERAM C 100NF 50V 2125SMD	S AA	AA
C 0367	VCKYTV1HF104Z	CERAM C 100NF 50V 2125SMD	S AA	AA
C 0368	RC-FZ4104BMNJ	POL FILM C 100nF 50V 5% ECQ-V PANASONIC	S AA	AB
C 0369	VCCCTV1HH101J	CERAM C 100PF 50V 2125SMD	S AA	AA
C 0370	RC-FZ4334BMNJ	POL FILM C 330nF 50V 5% ECQ-V PANASONIC	S AA	AB
C 0371	VCKYTV1HB102K	CERAM C 1NF 50V 2125SMD	S AA	AA
C 0372	VCEAGA1HW225M	ELEC C 2,2UF 20% 50V	S AA	AB
C 0373	RC-FZ4104BMNJ	POL FILM C 100nF 50V 5% ECQ-V PANASONIC	S AA	AB
C 0374	VCKYTV1HB472K	CERAM C 4,7NF 50V 2125SMD	S AA	AA
C 0375	VCCCTV1HH561J	CERAM C 560PF 50V 2125SMD	S AA	AA
C 0376	RC-FZ4474BMNJ	POL FILM C 470nF 50V 5% ECQ-V PANASONIC	S AA	AC
C 0377	VCEAGA1HW105M	ELEC C 1UF 20% 50V	S AA	AA
C 0378	VCEAGA1EW227M	ELEC C 220UF 20% 25V	S AA	AA
C 0379	VCKYTV1HF104Z	CERAM C 100NF 50V 2125SMD	S AA	AA
C 0380	VCKYTV1HF473Z	CERAM C 47NF 50V 2125SMD	S AA	AA
C 0386	VCCCTV1HH471J	CERAM C 470PF 50V 2125SMD	S AA	AA
C 0387	VCCCTV1HH471J	CERAM C 470PF 50V 2125SMD	S AA	AA
C 0408	VCKYTV1HF103Z	CERAM C 10NF 50V 2125SMD	S AA	AA
C 0409	VCCCTV1HH101J	CERAM C 100PF 50V 2125SMD	S AA	AA
C 0410	VCCCTV1HH391J	CERAM C 390PF 50V 2125SMD	S AA	AA
C 0411	VCCCTV1HH101J	CERAM C 100PF 50V 2125SMD	S AA	AA
C 0412	VCCCTV1HH101J	CERAM C 100PF 50V 2125SMD	S AA	AA
C 0413	VCCCTV1HH101J	CERAM C 100PF 50V 2125SMD	S AA	AA
C 0414	VCCCTV1HH391J	CERAM C 390PF 50V 2125SMD	S AA	AA
C 0415	VCEAGA1HW476M	ELEC C 47UF 20% 50V	S AA	AA
C 0416	VCCCTV1HH101J	CERAM C 100PF 50V 2125SMD	S AA	AA
C 0417	VCCCTV1HH101J	CERAM C 100PF 50V 2125SMD	S AA	AA
C 0418	VCCCTV1HH391J	CERAM C 390PF 50V 2125SMD	S AA	AA
C 0419	VCCCTV1HH391J	CERAM C 390PF 50V 2125SMD	S AA	AA
C 0420	VCCCTV1HH101J	CERAM C 100PF 50V 2125SMD	S AA	AA
C 0421	VCCCTV1HH101J	CERAM C 100PF 50V 2125SMD	S AA	AA
C 0422	VCEAGA1AW476M	ELEC C 47UF 20% 10V	S AA	AA
C 0427	VRS-TV1JD00J	2125 0 OHM 5% 1/10W SMD	S AA	AA
C 0433	VCEAGA1CW476M	ELEC C 47UF 20% 16V	S AA	AA
C 0434	VCKYTV1HF104Z	CERAM C 100NF 50V 2125SMD	S AA	AA
C 0435	VCKYTV1HF104Z	CERAM C 100NF 50V 2125SMD	S AA	AA
C 0436	VCKYTV1HF104Z	CERAM C 100NF 50V 2125SMD	S AA	AA
C 0439	VCCCTV1HH101J	CERAM C 100PF 50V 2125SMD	S AA	AA
C 0440	VCCCTV1HH101J	CERAM C 100PF 50V 2125SMD	S AA	AA
C 0442	VCCCTV1HH101J	CERAM C 100PF 50V 2125SMD	S AA	AA
C 0444	VCCCTV1HH680J	CERAM C 68PF 50V 2125SMD	S AA	AA
C 0445	VCCCTV1HH680J	CERAM C 68PF 50V 2125SMD	S AA	AA
C 0446	VCCCTV1HH680J	CERAM C 68PF 50V 2125SMD	S AA	AA
C 0501	VCEAGA1EW477M	ELEC C 470UF 20% 25V	S AA	AB
C 0502	VCKYTV1HF104Z	CERAM C 100NF 50V 2125SMD	S AA	AA
C 0503	VCCCTV1HH101J	CERAM C 100PF 50V 2125SMD	S AA	AA
C 0504	RC-FZ4684BMNJ	POL FILM C 680nF 50V 5% ECQ-V PANASONIC	S AA	AC
C 0505	VCKYTV1HF104Z	CERAM C 100NF 50V 2125SMD	S AA	AA
C 0506	VCKYTV1HF104Z	CERAM C 100NF 50V 2125SMD	S AA	AA
C 0507	VCKYTV1HB472K	CERAM C 4,7NF 50V 2125SMD	S AA	AA
C 0508	VCCCTV1HH561J	CERAM C 560PF 50V 2125SMD	S AA	AA
C 0509	VCEAGA1EW227M	ELEC C 220UF 20% 25V	S AA	AA
C 0510	VCKYTV1HF104Z	CERAM C 100NF 50V 2125SMD	S AA	AA
C 0511	VCEAGA1HW225M	ELEC C 2,2UF 20% 50V	S AA	AB
C 0512	VCKYTV1EF224Z	CERAM C 220NF 25V 2125SMD	S AA	AA
C 0514	RC-FZ4153BMNJ	POL FILM C 15nF 50V 5% ECQ-B PANASONIC	S AA	AB
C 0515	VCCCTV1HH391J	CERAM C 390PF 50V 2125SMD	S AA	AA
C 0516	VCCCTV1HH101J	CERAM C 100PF 50V 2125SMD	S AA	AA

REF No.	PARTS	DESCRIPTION	* SN CODE	EX CODE
C 0517	VCKYTV1HB472K	CERAM C 4,7NF 50V 2125SMD	S AA	AA
C 0518	VCCCTV1HH100D	CERAM C 10PF 50V 2125SMD	S AA	AA
C 0520	VCEAGA1VW477M	ELEC C 470UF 20% 35V	S AA	AB
C 0521	VCKYTV1HB102K	CERAM C 1NF 50V 2125SMD	S AA	AA
C 0522	VCKYTV1HF104Z	CERAM C 100NF 50V 2125SMD	S AA	AA
C 0523	VCKYTV1HB102K	CERAM C 1NF 50V 2125SMD	S AA	AA
C 0524	RC-FZ4104BMNJ	POL FILM C 100nF 50V 5% ECQ-V PANASONIC	S AA	AB
C 0525	VRS-TV1JD562J	2125 5,6KOHM 5% 1/10W SMD	S AA	AA
C 0526	VCEAGA1HW106M	ELEC C 100UF 20% 50V	S AA	AA
C 0527	VCKYTV1HF104Z	CERAM C 100NF 50V 2125SMD	S AA	AA
C 0528	VCEAGA1JW106M	ELEC C 100UF 20% 63V	S AA	AA
C 0529	VCCCTV1HH271J	CERAM C 270PF 50V 2125SMD	S AA	AA
C 0530	VCKYTV1HF103Z	CERAM C 10NF 50V 2125SMD	S AA	AA
C 0533	VCKYTV1HF103Z	CERAM C 10NF 50V 2125SMD	S AA	AA
C 0534	VCKYTV1HB102K	CERAM C 1NF 50V 2125SMD	S AA	AA
C 0535	VCCCTV1HH101J	CERAM C 100PF 50V 2125SMD	S AA	AA
C 0540	VCKYTV1HF104Z	CERAM C 100NF 50V 2125SMD	S AA	AA
C 0601	RC-FZ0158BMZZ	C B32633 10NF 1K6 SIEMENS	S AC	AF
C 0606	VCKYTV1HB104K	CERAM C 100NF 50V 2125SMD	S AA	AA
C 0607	VCEAGA1AW337M	ELEC C 330UF 20% 10V	S AA	AA
C 0610	RC-FZ0038CEZZ	C B32632 15NF 630V SIEMENS	S AC	AE
C 0611	RC-FZ7824BMNJ	FILM PP C 820NF 5% 400V	S AG	AK
C 0613	RC-FZ7684BMNJ	PP FILM C 680NF 5% 400V	S AE	AH
C 0615	VCEAGA1EW477M	ELEC C 470UF 20% 25V	S AA	AB
C 0616	VCEAGA1VW477M	ELEC C 470UF 20% 35V	S AA	AB
C 0618	RC-FZ4474BMNJ	POL FILM C 470nF 50V 5% ECQ-V PANASONIC	S AA	AC
C 0619	VCEAA42CN225M	C UVZ2C2R2MEH1TA NICHICON	S AA	AB
C 0620	VCEAA42CN225M	C UVZ2C2R2MEH1TA NICHICON	S AA	AB
C 0631	RC-FZ4474BMNJ	POL FILM C 470nF 50V 5% ECQ-V PANASONIC	S AA	AC
C 0633	VCCCTV1HH20J	CERAM C 22PF 50V 2125SMD	S AA	AA
C 0634	RC-KZ0038CEZZ	CERAM C 470PF 2KV	S AA	AB
C 0635	VCKYTV1HB102K	CERAM C 1NF 50V 2125SMD	S AA	AA
C 0637	VCKYPA2HB222K	CERAM C 2,2NF 10% 500V	S AA	AB
C 0638	VCKYPA2HB222K	CERAM C 2,2NF 10% 500V	S AA	AB
C 0639	VCCCTV1HH391J	CERAM C 390PF 50V 2125SMD	S AA	AA
C 0640	VCKYTV1HB222K	CERAM C 2,2NF 50V 2125SMD	S AA	AA
C 0644	VCEAGA1CW227M	ELEC C 220UF 20% 16V	S AA	AA
C 0645	VCCCTV1HH151J	CERAM C 150PF 50V 2125SMD	S AA	AA
C 0648	RC-FZ4273BMNJ	POL FILM C 27nF 50V 5% ECQ-B PANASONIC	S AA	AB
△ C 0701	RC-FZ0070BMZZ	PLAST C MET 0,1uF 250V B81121-C-B125	S AD	AD
C 0702	RC-FZ0173BMZZ	POL C 47NF 400V PHIL.365	S AN	AZ
C 0703	RC-KZ0165BMZZ	CERAM C DE0905-979E332ZAC250	S AA	AB
C 0704	RC-KZ0165BMZZ	CERAM C DE0905-979E332ZAC250	S AA	AB
C 0705	RC-EZ0141BMZZ	ELEC C 68UF 450V	S AD	AL
C 0706	VCEAGA1CW226M	ELEC C 22UF 20% 16V	S AA	AA
C 0707	VCEAGA1CW107M	ELEC C 100UF 20% 16V	S AA	AA
C 0710	RC-FZ0156BMZZ	C B32529-B6473K 47nF 400V SIEMENS	S AD	AE
C 0711	RC-KZ0035CEZZ	CERAM C 220PF 2KV	S AA	AC
C 0712	VCCCTV1HH101J	CERAM C 100PF 50V 2125SMD	S AA	AA
C 0713	RC-FZ4683BMNJ	POL FILM C 68nF 50V 5% ECQ-B PANASONIC	S AA	AB
C 0714	RC-FZ4823BMNJ	POL FILM C 82nF 50V 5% ECQ-B PANASONIC	S AA	AB
C 0715	VCCCTV1HH331J	CERAM C 330PF 50V 2125SMD	S AA	AA
C 0716	VCKYTV1HB332K	CERAM C 3,3NF 50V 2125SMD	S AA	AA
C 0717	VCKYTV1HB102K	CERAM C 1NF 50V 2125SMD	S AA	AA
C 0718	VCEAGA1EW108M	ELEC C 1000UF 20% 25V	S AD	AD
C 0719	VCEAGA1EW108M	ELEC C 1000UF 20% 25V	S AD	AD
C 0720	RC-EZ0258CEZZ	ELEC C 100MF 200V	S AC	AK
C 0721	RC-EZ0132BMZZ	C UVX1V471MPA1CA NICHICON	S AA	AC
C 0722	VCKYTV1HB104K	CERAM C 100NF 50V 2125SMD	S AA	AA
C 0723	VCEAGA1W228M	ELEC C 2200UF 20% 10V	S AA	AD
C 0724	VCEAGA1CW227M	ELEC C 220UF 20% 16V	S AA	AA
C 0725	VCKYTV1HB472K	CERAM C 4,7NF 50V 2125SMD	S AA	AA
C 0728	VCKYTV1HF104Z	CERAM C 100NF 50V 2125SMD	S AA	AA
C 0730	VCKYTV1HF103Z	CERAM C 10NF 50V 2125SMD	S AA	AA
C 0731	VCKYTV1HF103Z	CERAM C 10NF 50V 2125SMD	S AA	AA
C 0732	VCKYTV1HF103Z	CERAM C 10NF 50V 2125SMD	S AA	AA
C 0733	VCKYTV1HF103Z	CERAM C 10NF 50V 2125SMD	S AA	AA
C 0735	VCKYTV1HB272K	CERAM C 2,7NF 50V 2125SMD	S AA	AB
C 0737	VCKYTV1CF105Z	CERAM C 1UF 16V 2125SMD	S AA	AA
C 0738	VCCCTV1HH560J	CERAM C 56PF 50V 2125SMD	S AA	AA
C 0739	VCEAGA1CW227M	ELEC C 220UF 20% 16V	S AA	AA
C 0740	VCKYTV1HF223Z	CERAM C 22NF 50V 2125SMD	S AA	AA
C 0741	VCKYTV1HF104Z	CERAM C 100NF 50V 2125SMD	S AA	AA
C 0742	VCKYTV1HB683K	CERAM C 68NF 50V 2125SMD	S AA	AA

REF No.	PARTS	DESCRIPTION	* SN CODE	EX CODE	REF No.	PARTS	DESCRIPTION	* SN CODE	EX CODE
C 0743	VCKYTV1HF104Z	CERAM C 100NF 50V 2125SMD	S AA	AA	R 0313	VRS-TV1JD102J	2125 1KOHM 5% 1/10W SMD	S AA	AA
△ C 0746	RC-FZ0192BMZZ	C 330NF 275V X2 222233820334 PHILIPS	S AA	AC	R 0314	VRS-TV1JD104J	2125 100KOHM 5% 1/10W SMD	S AA	AA
C 0748	RC-KZ0160BMZZ	CERAM C 2,2NF 4KV X1Y1	S AA	AD	R 0315	VRD-RA2BE101J	RES 100 OHM 5% 1/8W	S AA	AA
C 0749	VCKYTV1CF474Z	CERAM C 470NF 16V 2125SMD	S AA	AA	R 0316	VRS-TV1JD391J	2125 390 OHM 5% 1/10W SMD	S AA	AA
△ C 0770	RC-KZ0106GEZZ	CERAM C DE1410 E332M-KX	S AB	AC	R 0317	VRS-TV1JD391J	2125 390 OHM 5% 1/10W SMD	S AA	AA
C 1001	VCEAGA0JW477M	ELEC C 470UF 20% 6.3V	S AA	AA	R 0318	VRS-TV1JD104J	2125 100KOHM 5% 1/10W SMD	S AA	AA
C 1002	VCKYTV1HF104Z	CERAM C 100NF 50V 2125SMD	S AA	AA	R 0319	VRS-TV1JD101J	2125 100 OHM 5% 1/10W SMD	S AA	AA
C 1005	VCKYTV1HF104Z	CERAM C 100NF 50V 2125SMD	S AA	AA	R 0320	VRS-TV1JD101J	2125 100 OHM 5% 1/10W SMD	S AA	AA
C 1014	VCKYTV1HF104Z	CERAM C 100NF 50V 2125SMD	S AA	AA	R 0321	VRS-TV1JD104J	2125 100KOHM 5% 1/10W SMD	S AA	AA
C 1017	VCKYTV1HF333Z	CERAM C 33NF 50V 2125SMD	S AA	AA	R 0322	VRS-TV1JD104J	2125 100KOHM 5% 1/10W SMD	S AA	AA
C 1018	VCKYTV1HF104Z	CERAM C 100NF 50V 2125SMD	S AA	AA	R 0323	VRS-TV1JD104J	2125 100KOHM 5% 1/10W SMD	S AA	AA
C 1019	VCCCTV1HH220J	CERAM C 22PF 50V 2125SMD	S AA	AA	R 0324	VRS-TV1JD103J	2125 10KOHM 5% 1/10W SMD	S AA	AA
C 1020	VCCCTV1HH220J	CERAM C 22PF 50V 2125SMD	S AA	AA	R 0351	VRS-TV1JD273J	2125 27KOHM 5% 1/10W SMD	S AA	AA
C 1021	VCKYTV1HF104Z	CERAM C 100NF 50V 2125SMD	S AA	AA	R 0352	VRS-TV1JD123J	2125 12KOHM 5% 1/10W SMD	S AA	AA
C 1022	VCKYTV1HF104Z	CERAM C 100NF 50V 2125SMD	S AA	AA	R 0353	VRS-TV1JD151J	2125 150 OHM 5% 1/10W SMD	S AA	AA
C 1026	VCKYTV1HF103Z	CERAM C 10NF 50V 2125SMD	S AA	AA	R 0354	VRS-TV1JD103J	2125 10KOHM 5% 1/10W SMD	S AA	AA
C 1027	VCEAGA1CW476M	ELEC C 47UF 20% 16V	S AA	AA	R 0355	VRS-TV1JD273J	2125 27KOHM 5% 1/10W SMD	S AA	AA
C 1028	VCKYTV1HF104Z	CERAM C 100NF 50V 2125SMD	S AA	AA	R 0356	VRS-TV1JD123J	2125 12KOHM 5% 1/10W SMD	S AA	AA
C 1030	VCCCTV1HH331J	CERAM C 330PF 50V 2125SMD	S AA	AA	R 0357	VRS-TV1JD151J	2125 150 OHM 5% 1/10W SMD	S AA	AA
C 1031	VCKZPA1HF103Z	CERAM C 10NF % 50V	S AA	AA	R 0358	VRS-TV1JD104J	2125 100KOHM 5% 1/10W SMD	S AA	AA
C 1032	VCEAGA1HW225M	ELEC C 2,2UF 20% 50V	S AA	AB	R 0359	VRD-RA2BE104J	RES 100KOHM 5% 1/8W	S AA	AA
C 1033	VCKYTV1HF683Z	CERAM C 68NF 50V 2125SMD	S AA	AA	R 0360	VRS-TV1JD103J	2125 10KOHM 5% 1/10W SMD	S AA	AA
C 2401	VCCCTV1HH220J	CERAM C 22PF 50V 2125SMD	S AA	AA	R 0361	VRS-TV1JD103J	2125 10KOHM 5% 1/10W SMD	S AA	AA
C 2402	VCCCTV1HH220J	CERAM C 22PF 50V 2125SMD	S AA	AA	R 0362	VRS-TV1JD472J	2125 4.7KOHM 5% 1/10W SMD	S AA	AA
C 2403	VCKYTV1HF104Z	CERAM C 100NF 50V 2125SMD	S AA	AA	R 0363	VRS-TV1JD472J	2125 4.7KOHM 5% 1/10W SMD	S AA	AA
C 2404	VCKYTV1HF104Z	CERAM C 100NF 50V 2125SMD	S AA	AA	R 0372	VRS-TV1JD103J	2125 10KOHM 5% 1/10W SMD	S AA	AA
C 2405	VCKYTV1EF224Z	CERAM C 220NF 25V 2125SMD	S AA	AA	R 0373	VRS-TV1JD103J	2125 10KOHM 5% 1/10W SMD	S AA	AA
C 2406	VCKYTV1HF104Z	CERAM C 100NF 50V 2125SMD	S AA	AA	R 0374	VRS-TV1JD473J	2125 47KOHM 5% 1/10W SMD	S AA	AA
C 2407	VCKYTV1EF224Z	CERAM C 220NF 25V 2125SMD	S AA	AA	R 0375	VRS-TV1JD473J	2125 47KOHM 5% 1/10W SMD	S AA	AA
		RESISTORS			R 0376	VRS-TV1JD472J	2125 4.7KOHM 5% 1/10W SMD	S AA	AA
R 0203	VRS-TV1JD102J	2125 1KOHM 5% 1/10W SMD	S AA	AA	R 0379	VRD-RA2BE330J	RES 33 OHM 5% 1/8W	S AA	AA
R 0204	VRS-TV1JD102J	2125 1KOHM 5% 1/10W SMD	S AA	AA	R 0380	VRD-RA2BE330J	RES 33 OHM 5% 1/8W	S AA	AA
R 0205	VRS-TV1JD331J	2125 330 OHM 5% 1/10W SMD	S AA	AA	R 0381	VRD-RA2BE330J	RES 33 OHM 5% 1/8W	S AA	AA
R 0208	VRS-TV1JD102J	2125 1KOHM 5% 1/10W SMD	S AA	AA	R 0382	VRD-RA2BE330J	RES 33 OHM 5% 1/8W	S AA	AA
R 0209	VRS-TV1JD332J	2125 3.3KOHM 5% 1/10W SMD	S AA	AA	R 0408	VRD-RA2EE750J	RES 75 OHM 5% 1/4W	S AA	AA
R 0210	VRS-TV1JD152J	2125 1.5KOHM 5% 1/10W SMD	S AA	AA	R 0409	VRS-TV1JD750J	2125 75 OHM 5% 1/10W SMD	S AA	AA
R 0211	VRS-TV1JD102J	2125 1KOHM 5% 1/10W SMD	S AA	AA	R 0410	VRS-TV1JD223F	2125 22KOHM 1% 1/10W SMD	S AA	AA
R 0216	VRS-TV1JD151J	2125 150 OHM 5% 1/10W SMD	S AA	AA	R 0412	VRS-TV1JD101J	2125 100 OHM 5% 1/10W SMD	S AA	AA
R 0217	VRS-TV1JD681J	2125 680 OHM 5% 1/10W SMD	S AA	AA	R 0413	VRS-TV1JD101J	2125 100 OHM 5% 1/10W SMD	S AA	AA
R 0218	VRS-TV1JD123J	2125 12KOHM 5% 1/10W SMD	S AA	AA	R 0414	VRS-TV1JD101J	2125 100 OHM 5% 1/10W SMD	S AA	AA
R 0219	VRS-TV1JD473J	2125 47KOHM 5% 1/10W SMD	S AA	AA	R 0415	VRS-TV1JD101J	2125 100 OHM 5% 1/10W SMD	S AA	AA
R 0220	VRS-TV1JD473J	2125 47KOHM 5% 1/10W SMD	S AA	AA	R 0416	VRS-TV1JD223F	2125 22KOHM 1% 1/10W SMD	S AA	AA
R 0226	VRS-TV1JD000J	2125 0 OHM 5% 1/10W SMD	S AA	AA	R 0418	VRD-RA2BE750J	RES 75 OHM 5% 1/8W	S AA	AA
R 0229	VRD-RA2HD822J	RES 8.2KOHM 5% 1/2W	S AA	AA	R 0419	VRD-RA2EE750J	RES 75 OHM 5% 1/4W	S AA	AA
R 0230	VRD-RA2HD822J	RES 8.2KOHM 5% 1/2W	S AA	AA	R 0420	VRD-RA2BE102J	RES 1KOHM 5% 1/8W	S AA	AA
R 0231	VRD-RA2HD822J	RES 8.2KOHM 5% 1/2W	S AA	AA	R 0421	VRS-TV1JD750J	2125 75 OHM 5% 1/10W SMD	S AA	AA
R 0232	VRD-RA2BE561J	RES 560 OHM 5% 1/8W	S AA	AA	R 0422	VRS-TV1JD750J	2125 75 OHM 5% 1/10W SMD	S AA	AA
R 0233	VRD-RA2BE561J	RES 560 OHM 5% 1/8W	S AA	AA	R 0423	VRS-TV1JD750J	2125 75 OHM 5% 1/10W SMD	S AA	AA
R 0235	VRS-TV1JD222J	2125 2.2KOHM 5% 1/10W SMD	S AA	AA	R 0424	VRD-RA2BE750J	RES 75 OHM 5% 1/8W	S AA	AA
R 0236	VRS-TV1JD102J	2125 1KOHM 5% 1/10W SMD	S AA	AA	R 0425	VRD-RA2EE750J	RES 75 OHM 5% 1/4W	S AA	AA
R 0237	VRS-TV1JD681J	2125 680 OHM 5% 1/10W SMD	S AA	AA	R 0426	VRD-RA2BE750J	RES 75 OHM 5% 1/8W	S AA	AA
R 0240	VRS-TV1JD224J	2125 22KOHM 5% 1/10W SMD	S AA	AA	R 0427	VRS-TV1JD820J	2125 82 OHM 5% 1/10W SMD	S AA	AA
R 0241	VRS-TV1JD104J	2125 100KOHM 5% 1/10W SMD	S AA	AA	R 0428	VRS-TV1JD101J	2125 100 OHM 5% 1/10W SMD	S AA	AA
R 0242	VRS-TV1JD103J	2125 10KOHM 5% 1/10W SMD	S AA	AA	R 0429	VRS-TV1JD101J	2125 100 OHM 5% 1/10W SMD	S AA	AA
R 0243	VRS-TV1JD103J	2125 10KOHM 5% 1/10W SMD	S AA	AA	R 0430	VRS-TV1JD101J	2125 100 OHM 5% 1/10W SMD	S AA	AA
R 0244	VRS-TV1JD333J	2125 33KOHM 5% 1/10W SMD	S AA	AA	R 0431	VRS-TV1JD101J	2125 100 OHM 5% 1/10W SMD	S AA	AA
R 0245	VRS-TV1JD152J	2125 1.5KOHM 5% 1/10W SMD	S AA	AA	R 0432	VRS-TV1JD104J	2125 100KOHM 5% 1/10W SMD	S AA	AA
R 0246	VRS-TV1JD224J	2125 22KOHM 5% 1/10W SMD	S AA	AA	R 0433	VRS-TV1JD104J	2125 100KOHM 5% 1/10W SMD	S AA	AA
R 0247	VRS-TV1JD102J	2125 1KOHM 5% 1/10W SMD	S AA	AA	R 0434	VRS-TV1JD102J	2125 1KOHM 5% 1/10W SMD	S AA	AA
R 0248	VRS-TV1JD000J	2125 0 OHM 5% 1/10W SMD	S AA	AA	R 0435	VRS-TV1JD102J	2125 1KOHM 5% 1/10W SMD	S AA	AA
R 0251	VRS-TV1JD683J	2125 68KOHM 5% 1/10W SMD	S AA	AA	R 0436	RR-XZ0112BMZZ	FUS RES 10R TAP 5% 1/3W	S AA	AB
R 0252	VRS-TV1JD183J	2125 18KOHM 5% 1/10W SMD	S AA	AA	R 0437	VRS-TV1JD471J	2125 470 OHM 5% 1/10W SMD	S AA	AA
R 0301	VRS-TV1JD104J	2125 100KOHM 5% 1/10W SMD	S AA	AA	R 0450	VRS-TV1JD220J	2125 22 OHM 5% 1/10W SMD	S AA	AA
R 0302	VRS-TV1JD104J	2125 100KOHM 5% 1/10W SMD	S AA	AA	R 0451	VRD-RA2HD121J	RES 120 OHM 5% 1/2W	S AA	AA
R 0303	VRS-TV1JD101J	2125 100 OHM 5% 1/10W SMD	S AA	AA	R 0454	VRS-TV1JD331J	2125 330 OHM 5% 1/10W SMD	S AA	AA
R 0304	VRS-TV1JD101J	2125 100 OHM 5% 1/10W SMD	S AA	AA	R 0455	VRD-RA2BE103J	RES 10KOHM 5% 1/8W	S AA	AA
R 0306	VRD-RA2BE101J	RES 100 OHM 5% 1/8W	S AA	AA	R 0456	VRS-TV1JD153J	2125 15KOHM 5% 1/10W SMD	S AA	AA
R 0307	VRD-RA2BE101J	RES 100 OHM 5% 1/8W	S AA	AA	R 0460	VRS-TV1JD183F	2125 18KOHM 1% 1/10W SMD	S AA	AA
R 0308	VRS-TV1JD101J	2125 100 OHM 5% 1/10W SMD	S AA	AA	R 0462	VRS-TV1JD183F	2125 18KOHM 1% 1/10W SMD	S AA	AA
R 0309	VRS-TV1JD223J	2125 22KOHM 5% 1/10W SMD	S AA	AA	R 0463	VRS-TV1JD101J	2125 100 OHM 5% 1/10W SMD	S AA	AA
R 0310	VRS-TV1JD102J	2125 1KOHM 5% 1/10W SMD	S AA	AA	R 0464	VRD-RA2BE221J	RES 220 OHM 5% 1/8W	S AA	AA
R 0311	VRS-TV1JD104J	2125 100KOHM 5% 1/10W SMD	S AA	AA	R 0468	VRS-TV1JD000J	2125 0 OHM 5% 1/10W SMD	S AA	AA
R 0312	VRS-TV1JD223J	2125 22KOHM 5% 1/10W SMD	S AA	AA	R 0469	VRS-TV1JD750J	2125 75 OHM 5% 1/10W SMD	S AA	AA
					R 0501	VRD-RA2HD151J	RES 150 OHM 5% 1/2W	S AA	AA

REF No.	PARTS	DESCRIPTION	* SN CODE	EX CODE
R 0502	VRS-TV1JD472J	2125 4.7KOHM 5% 1/10W SMD	S AA	AA
R 0503	VRD-RA2BE102J	RES 1KOHM 5% 1/8W	S AA	AA
R 0504	VRS-TV1JD393J	2125 39KOHM 5% 1/10W SMD	S AA	AA
R 0505	VRS-TV1JD222J	2125 2.2KOHM 5% 1/10W SMD	S AA	AA
R 0506	VRS-TQ2BD121J	OX RE 120 OHM 5% 1/8W SMD	S AA	AA
R 0507	VRS-TV1JD822J	2125 8.2KOHM 5% 1/10W SMD	S AA	AA
R 0508	VRD-RA2BE681J	RES 680 OHM 5% 1/8W	S AA	AA
R 0509	VRS-TV1JD393J	2125 39KOHM 5% 1/10W SMD	S AA	AA
R 0510	VRS-TV1JD822J	2125 8.2KOHM 5% 1/10W SMD	S AA	AA
R 0511	VRS-TV1JD151J	2125 150 OHM 5% 1/10W SMD	S AA	AA
R 0512	VRS-TV1JD472J	2125 4.7KOHM 5% 1/10W SMD	S AA	AA
R 0513	VRS-TV1JD104J	2125 100KOHM 5% 1/10W SMD	S AA	AA
R 0514	VRS-TV1JD391J	2125 390 OHM 5% 1/10W SMD	S AA	AA
R 0515	VRS-TV1JD122J	2125 1.2KOHM 5% 1/10W SMD	S AA	AA
R 0516	VRS-TV1JD102J	2125 1KOHM 5% 1/10W SMD	S AA	AA
R 0517	VRS-TV1JD153J	2125 15KOHM 5% 1/10W SMD	S AA	AA
R 0518	VRN-VV3DB1R0J	MET FILM R 1 OHM 5% 2W	S AA	AA
R 0519	VRD-RA2HD104J	RES 100KOHM 5% 1/2W	S AA	AA
R 0521	VRS-TV1JD562J	2125 5.6KOHM 5% 1/10W SMD	S AA	AA
R 0522	VRS-TV1JD331J	2125 330 OHM 5% 1/10W SMD	S AA	AA
R 0524	VRS-TV1JD102J	2125 1KOHM 5% 1/10W SMD	S AA	AA
R 0525	VRS-TV1JD103J	2125 10KOHM 5% 1/10W SMD	S AA	AA
R 0526	VRD-RA2BE332J	RES 3.3KOHM 5% 1/8W	S AA	AA
R 0527	VRS-TV1JD102J	2125 1KOHM 5% 1/10W SMD	S AA	AA
R 0528	VRS-TV1JD473J	2125 47KOHM 5% 1/10W SMD	S AA	AA
R 0530	RR-XZ0200BMZZ	FUS RES 1R0 TAP 5% 1/2W	S AA	AB
R 0532	VRS-TV1JD682J	2125 6.8KOHM 5% 1/10W SMD	S AA	AA
R 0533	VRD-RA2EE821J	RES 820 OHM 5% 1/4W	S AA	AA
R 0534	VRD-RA2BE273J	RES 27KOHM 5% 1/8W	S AA	AA
R 0535	VRS-TV1JD682J	2125 6.8KOHM 5% 1/10W SMD	S AA	AA
R 0536	VRS-VV3DB102J	MET OX RES 1KOHM 5% 2W	S AA	AA
R 0537	VRS-TV1JD822J	2125 8.2KOHM 5% 1/10W SMD	S AA	AA
R 0538	VRS-TV1JD273J	2125 27KOHM 5% 1/10W SMD	S AA	AA
R 0539	VRS-TV1JD332J	2125 3.3KOHM 5% 1/10W SMD	S AA	AA
R 0540	VRS-TV1JD472J	2125 4.7KOHM 5% 1/10W SMD	S AA	AA
R 0544	VRS-TV1JD102J	2125 1KOHM 5% 1/10W SMD	S AA	AA
R 0545	VRS-TV1JD104J	2125 100KOHM 5% 1/10W SMD	S AA	AA
R 0547	VRS-TV1JD392J	2125 3.9KOHM 5% 1/10W SMD	S AA	AA
R 0548	VRS-TV1JD682J	2125 6.8KOHM 5% 1/10W SMD	S AA	AA
R 0549	VRS-TV1JD273J	2125 27KOHM 5% 1/10W SMD	S AA	AA
R 0552	VRS-TV1JD332J	2125 3.3KOHM 5% 1/10W SMD	S AA	AA
R 0553	RR-XZ0101BMZZ	FUS RES 1R2 TAP 5% 1/3W	S AA	AB
R 0561	VRS-TV1JD102J	2125 1KOHM 5% 1/10W SMD	S AA	AA
R 0562	VRS-TV1JD102J	2125 1KOHM 5% 1/10W SMD	S AA	AA
R 0603	VRD-RA2BE331J	RES 330 OHM 5% 1/8W	S AA	AA
R 0604	VRN-VV3LB2R2J	MET FILM R 2.2 OHM 5% 3W	S AA	AB
R 0605	VRS-TV1JD222J	2125 2.2KOHM 5% 1/10W SMD	S AA	AA
R 0606	VRS-VV3AB330J	MET OX RES 33 OHM 5% 1W	S AA	AA
R 0607	VRS-TV1JD682J	2125 6.8KOHM 5% 1/10W SMD	S AA	AA
R 0608	VRD-RA2EE330J	RES 33 OHM 5% 1/4W	S AA	AA
R 0609	VRN-VV3ABR33J	MET FILM R .33 OHM 5% 1W	S AA	AA
R 0610	RR-XZ0200BMZZ	FUS RES 1R0 TAP 5% 1/2W	S AA	AB
R 0611	VRS-VV3DB561J	MET OX RES 560 OHM 5% 2W	S AA	AA
R 0612	RR-XZ0206BMZZ	FUS RES 3R3 TAP 5% 1/2W	S AA	AB
R 0613	VRS-LU3DB222J	SET MET OX R 2.2KOHM 5% 2W LW	S AA	AB
R 0614	VRD-RA2HD103J	RES 10KOHM 5% 1/2W	S AA	AA
R 0615	VRS-TV1JD562J	2125 5.6KOHM 5% 1/10W SMD	S AA	AA
R 0617	RR-XZ0216BMZZ	FUS RES 22R TAP 5% 1/2W	S AA	AB
R 0619	VRS-VV3DB271J	MET OX RES 270 OHM 5% 2W	S AA	AA
R 0623	VRN-VV3LBR56J	MET FILM R 0.56 OHM 5% 3W	S AA	AB
R 0625	VRS-TQ2BD181J	OX RE 180 OHM 5% 1/8W SMD	S AA	AA
R 0627	VRS-TQ2BD181J	OX RE 180 OHM 5% 1/8W SMD	S AA	AA
R 0628	VRD-RA2EE330J	RES 33 OHM 5% 1/4W	S AA	AA
R 0634	VRS-TV1JD222J	2125 2.2KOHM 5% 1/10W SMD	S AA	AA
R 0641	VRD-RA2HD470J	RES 47 OHM 5% 1/2W	S AA	AA
R 0643	RR-XZ0100BMZZ	FUS RES 1R0 TAP 5% 1/3W	S AA	AB
R 0646	VRS-TV1JD105J	2125 1MOHM 5% 1/10W SMD	S AA	AA
R 0647	VRS-TV1JD000J	2125 0 OHM 5% 1/10W SMD	S AA	AA
R 0703	VRD-RA2HD154J	RES 150KOHM 5% 1/2W	S AA	AA
R 0706	VRS-TV1JD203J	2125 20KOHM 5% 1/10W SMD	S AA	AA
R 0707	VRS-TV1JD912J	2125 9.1KOHM 5% 1/10W SMD	S AA	AA
R 0708	VRS-TV1JD102J	2125 1KOHM 5% 1/10W SMD	S AA	AA
R 0711	VRS-TV1JD122J	2125 1.2KOHM 5% 1/10W SMD	S AA	AA
R 0712	VRS-TV1JD331J	2125 330 OHM 5% 1/10W SMD	S AA	AA

REF No.	PARTS	DESCRIPTION	* SN CODE	EX CODE
R 0713	VRC-MA2HG564J	SOLID R 560KOHM 5% 1/2W	S AA	AA
R 0714	VRC-MA2HG564J	SOLID R 560KOHM 5% 1/2W	S AA	AA
R 0715	VRW-KS3HC473J	WOUND RES 47KOHM 5% 5W	S AA	AE
R 0716	VRN-VV3ABR271J	MET FILM R .27 OHM 5% 1W	S AA	AA
R 0717	VRS-TV1JD223J	2125 22KOHM 5% 1/10W SMD	S AA	AA
R 0718	VRS-VV3AB200J	3216 0 OHM 5% 1/8W SMD	S AA	AA
R 0719	VRS-TV1JD221J	2125 220 OHM 5% 1/10W SMD	S AA	AA
R 0720	VRS-TV1JD103J	2125 10KOHM 5% 1/10W SMD	S AA	AA
R 0721	VRD-RA2HD154J	RES 150KOHM 5% 1/2W	S AA	AA
R 0722	VRS-TV1JD330J	2125 33 OHM 5% 1/10W SMD	S AA	AA
R 0723	VRS-VV3AB271J	MET OX RES 270 OHM 5% 1W	S AA	AA
R 0724	VRS-TQ2BD221J	OX RE 220 OHM 5% 1/8W SMD	S AA	AA
R 0727	VRD-RA2HD181J	RES 180 OHM 5% 1/2W	S AA	AA
R 0728	VRD-RA2HD181J	RES 180 OHM 5% 1/2W	S AA	AA
R 0730	VRS-VV3AB820J	MET OX RES 82 OHM 5% 1W	S AA	AA
R 0733	VRS-TV1JD473J	2125 47KOHM 5% 1/10W SMD	S AA	AA
R 0735	VRS-TV1JD474J	2125 470KOHM 5% 1/10W SMD	S AA	AA
R 0736	VRS-TV1JD474J	2125 470KOHM 5% 1/10W SMD	S AA	AA
R 0737	VRS-TV1JD184J	2125 180KOHM 5% 1/10W SMD	S AA	AA
R 0738	VRS-TV1JD473J	2125 47KOHM 5% 1/10W SMD	S AA	AA
R 0739	VRS-TV1JD473J	2125 47KOHM 5% 1/10W SMD	S AA	AA
R 0740	VRS-TV1JD473J	2125 47KOHM 5% 1/10W SMD	S AA	AA
△ R 0741	VRC-UA2HG825K	SOLID R 8.2MOHM 10% 1/2W	S AA	AA
△ R 0742	VRC-UA2HG825K	SOLID R 8.2MOHM 10% 1/2W	S AA	AA
R 0743	VRS-TQ2BD473F	OX RE 47KOHM 1% 1/8W	S AA	AA
R 0744	VRS-TQ2BD473F	OX RE 47KOHM 1% 1/8W	S AA	AA
R 0745	VRS-TV1JD182F	2125 1.8KOHM 1% 1/10W SMD	S AA	AA
R 0746	VRS-TV1JD333J	2125 33KOHM 5% 1/10W SMD	S AA	AA
R 0747	VRS-TV1JD272J	2125 2.7KOHM 5% 1/10W SMD	S AA	AA
R 0748	VRS-TV1JD472J	2125 4.7KOHM 5% 1/10W SMD	S AA	AA
R 0750	VRS-TV1JD334J	2125 330KOHM 5% 1/10W SMD	S AA	AA
R 0751	VRS-TV1JD102J	2125 1KOHM 5% 1/10W SMD	S AA	AA
R 0754	VRS-TV1JD2R7J	2125 2.7 OHM 5% 1/10W SMD	S AA	AA
R 0755	VRS-TV1JD391J	2125 390 OHM 5% 1/10W SMD	S AA	AA
R 0758	VRS-TV1JD101J	2125 100 OHM 5% 1/10W SMD	S AA	AA
R 0762	VRS-TQ2BD221J	OX RE 220 OHM 5% 1/8W SMD	S AA	AA
R 0763	RR-XZ0224BMZZ	FUS RES 100R TAP 5% 1/2W	S AA	AB
R 0765	VRS-TQ2BD101J	OX RE 100 OHM 5% 1/8W SMD	S AA	AA
R 0766	VRS-TQ2BD101J	OX RE 100 OHM 5% 1/8W SMD	S AA	AA
R 0767	VRS-TV1JD103J	2125 10KOHM 5% 1/10W SMD	S AA	AA
R 0768	VRS-TQ2BD221J	OX RE 220 OHM 5% 1/8W SMD	S AA	AA
R 0769	VRS-TV1JD821J	2125 820 OHM 5% 1/10W SMD	S AA	AA
R 0770	RR-XZ0229BMZZ	FUS RES 270R TAP 5% 1/2W	S AA	AA
R 0771	VRS-VV3AB474J	MET OX RES 470KOHM 5% 1W	S AA	AA
R 0774	VRD-RA2BD474J	OX RE 470KOHM 5% 1/8W SMD	S AA	AA
R 0775	VRS-TQ2BD474J	OX RE 470KOHM 5% 1/8W SMD	S AA	AA
R 0776	VRS-TV1JD823J	2125 82KOHM 5% 1/10W SMD	S AA	AA
R 0777	VRS-TV1JD470J	2125 47 OHM 5% 1/10W SMD	S AA	AA
R 0778	VRD-RA2HD105J	RES 1MOHM 5% 1/2W	S AA	AA
R 0787	VRS-TV1JD473J	2125 47KOHM 5% 1/10W SMD	S AA	AA
R 0788	VRS-TV1JD183J	2125 18KOHM 5% 1/10W SMD	S AA	AA
R 0789	VRS-TV1JD183J	2125 18KOHM 5% 1/10W SMD	S AA	AA
R 0790	VRD-RA2BE183J	RES 18KOHM 5% 1/8W	S AA	AA
R 0791	VRD-RA2BE183J	RES 18KOHM 5% 1/8W	S AA	AA
R 0792	VRD-RA2BE682J	RES 6.8KOHM 5% 1/8W	S AA	AA
R 1001	VRS-TV1JD332J	2125 3.3KOHM 5% 1/10W SMD	S AA	AA
R 1002	VRS-TV1JD332J	2125 3.3KOHM 5% 1/10W SMD	S AA	AA
R 1003	VRS-TV1JD332J	2125 3.3KOHM 5% 1/10W SMD	S AA	AA
R 1004	VRS-TV1JD332J	2125 3.3KOHM 5% 1/10W SMD	S AA	AA
R 1005	VRS-TV1JD472J	2125 4.7KOHM 5% 1/10W SMD	S AA	AA
R 1017	VRS-TV1JD102J	2125 1KOHM 5% 1/10W SMD	S AA	AA
R 1018	VRD-RA2BE101J	RES 100 OHM 5% 1/8W	S AA	AA
R 1019	VRS-TV1JD332J	2125 3.3KOHM 5% 1/10W SMD	S AA	AA
R 1020	VRS-TV1JD332J	2125 3.3KOHM 5% 1/10W SMD	S AA	AA
R 1021	VRS-TV1JD472J	2125 4.7KOHM 5% 1/10W SMD	S AA	AA
R 1022	VRD-RA2BE101J	RES 100 OHM 5% 1/8W	S AA	AA
R 1023	VRS-TV1JD221J	2125 220 OHM 5% 1/10W SMD	S AA	AA
R 1024	VRS-TV1JD822J	2125 8.2KOHM 5% 1/10W SMD	S AA	AA
R 1025	VRS-TV1JD822J	2125 8.2KOHM 5% 1/10W SMD	S AA	AA
R 1026	VRS-TV1JD221J	2125 220 OHM 5% 1/10W SMD	S AA	AA
R 1027	VRD-RA2BE103J	RES 10KOHM 5% 1/8W	S AA	AA
R 1028	VRS-TV1JD101J	2125 100 OHM 5% 1/10W SMD	S AA	AA
R 1029	VRS-TV1JD472J	2125 4.7KOHM 5% 1/10W SMD	S AA	AA
R 1030	VRS-TV1JD472J	2125 4.7KOHM 5% 1/10W SMD	S AA	AA

REF No.	PARTS	DESCRIPTION	* SN CODE	EX CODE
R 1031	VRS-TV1JD472J	2125 4.7KOHM 5% 1/10W SMD	S AA	AA
R 1032	VRS-TV1JD273J	2125 27KOHM 5% 1/10W SMD	S AA	AA
R 1035	VRS-TV1JD472J	2125 4.7KOHM 5% 1/10W SMD	S AA	AA
R 1036	VRD-RA2BE472J	RES 4.7KOHM 5% 1/8W	S AA	AA
R 1037	VRS-TV1JD472J	2125 4.7KOHM 5% 1/10W SMD	S AA	AA
R 1038	VRS-TV1JD101J	2125 100 OHM 5% 1/10W SMD	S AA	AA
R 1039	VRS-TV1JD101J	2125 100 OHM 5% 1/10W SMD	S AA	AA
R 1040	VRS-TV1JD101J	2125 100 OHM 5% 1/10W SMD	S AA	AA
R 1041	VRS-TV1JD472J	2125 4.7KOHM 5% 1/10W SMD	S AA	AA
R 1042	VRS-TV1JD822J	2125 8.2KOHM 5% 1/10W SMD	S AA	AA
R 1043	VRS-TV1JD822J	2125 8.2KOHM 5% 1/10W SMD	S AA	AA
R 1044	VRS-TV1JD103J	2125 10KOHM 5% 1/10W SMD	S AA	AA
R 1045	VRS-TV1JD822J	2125 8.2KOHM 5% 1/10W SMD	S AA	AA
R 1046	VRS-TV1JD182J	2125 1.8KOHM 5% 1/10W SMD	S AA	AA
R 1047	VRD-RA2BE103J	RES 10KOHM 5% 1/8W	S AA	AA
R 1048	VRS-TV1JD821J	2125 8.2KOHM 5% 1/10W SMD	S AA	AA
R 1049	VRS-TV1JD103J	2125 10KOHM 5% 1/10W SMD	S AA	AA
R 1050	VRD-RA2BE221J	RES 220 OHM 5% 1/8W	S AA	AA
R 1051	VRS-TV1JD223J	2125 22KOHM 5% 1/10W SMD	S AA	AA
R 1052	VRS-TV1JD472J	2125 4.7KOHM 5% 1/10W SMD	S AA	AA
R 1053	VRS-TV1JD104J	2125 100KOHM 5% 1/10W SMD	S AA	AA
R 1054	VRS-TV1JD104J	2125 100KOHM 5% 1/10W SMD	S AA	AA
R 1055	VRD-RA2BE474J	RES 47KOHM 5% 1/8W	S AA	AA
R 1056	VRS-TV1JD000J	2125 0 OHM 5% 1/10W SMD	S AA	AA
R 1058	VRD-RA2BE101J	RES 100 OHM 5% 1/8W	S AA	AA
R 1059	VRD-RA2BE101J	RES 100 OHM 5% 1/8W	S AA	AA
R 2401	VRS-TV1JD471J	2125 470 OHM 5% 1/10W SMD	S AA	AA
R 2402	VRS-TV1JD472J	2125 4.7KOHM 5% 1/10W SMD	S AA	AA
R 2403	VRS-TV1JD152J	2125 1.5KOHM 5% 1/10W SMD	S AA	AA
R 2404	VRS-TV1JD560J	2125 56 OHM 5% 1/10W SMD	S AA	AA
R 2405	VRS-TV1JD104J	2125 100KOHM 5% 1/10W SMD	S AA	AA
R 2406	VRS-TV1JD222J	2125 2.2KOHM 5% 1/10W SMD	S AA	AA
R 2407	VRS-TV1JD222J	2125 2.2KOHM 5% 1/10W SMD	S AA	AA
R 2408	VRS-TV1JD332J	2125 3.3KOHM 5% 1/10W SMD	S AA	AA
R 2409	VRS-TV1JD271J	2125 270 OHM 5% 1/10W SMD	S AA	AA
R 2410	VRS-TV1JD101J	2125 100 OHM 5% 1/10W SMD	S AA	AA
R 2411	VRS-TV1JD101J	2125 100 OHM 5% 1/10W SMD	S AA	AA
R 2412	VRS-TV1JD101J	2125 100 OHM 5% 1/10W SMD	S AA	AA
MISCELLANEOUS PARTS				
(A)	QPLGN0304CEZZ	PLUG	S AA	AB
(AV)	QCWN-2736BMZZ	WIRE 1 WAY	S AA	AF
(CN2)	QSOCZ2107BMZZ	SOCKET	S AF	AE
(CN1)	QSOCZ2107BMZZ	SOCKET	S AF	AE
(F)	QPLGN1505BMZZ	HEADER 4+1 JST B05B-DVS-L	S AA	AC
(G)	QPLGN0207CEZZ	PLUG	S AA	AA
(PW)	QCNCM0672FCZZ	CONN B2P3-VH JST	S AA	AB
(RG)	QPLGN0441CEZZ	PLUG 4PIN	S AA	AA
(SP)	QPLGN0441CEZZ	PLUG 4PIN	S AA	AA
(YA)	QSOCN1285CEZZ	SOCKET	S AA	AD
(YB)	QSOCN1285CEZZ	SOCKET	S AA	AD
(YC)	QSOCN1285CEZZ	SOCKET	S AA	AD
△ F 0701	QFS-C3226CEZZ	FUSE T3.15AH 250V	S AC	AE
FB 0302	RBLN-0037CEZZ	BALUN FBA04HA90088-00 TTY	S AB	AB
FB 0303	RBLN-0037CEZZ	BALUN FBA04HA90088-00 TTY	S AB	AB
FB 0501	RBLN-0020CEZZ	BALUNE	S AA	AB
FB 0603	RBLN-0037CEZZ	BALUN FBA04HA90088-00 TTY	S AB	AB
FB 0701	RBLN-0037CEZZ	BALUN FBA04HA90088-00 TTY	S AB	AB
FB 0702	RBLN-0037CEZZ	BALUN FBA04HA90088-00 TTY	S AB	AB
FB 0703	RBLN-0037CEZZ	BALUN FBA04HA90088-00 TTY	S AB	AB
FB 0705	RBLN-0020CEZZ	BALUNE	S AA	AB
FB 1001	VRS-TQ2B000J	3216 0 OHM 5% 1/8W SMD	S AA	AA
J 0002	VRS-TV1JD000J	2125 0 OHM 5% 1/10W SMD	S AA	AA
J 0012	QFS-J2521CEZZ	FUSE 2.5A/125V LITTELFUSE	S AC	AD
J 0013	VP-CF3R3K0000	PEAK COIL 3.3UH 10%	S AB	AB
J 0014	QFS-J2521CEZZ	FUSE 2.5A/125V LITTELFUSE	S AC	AD
J 0098	VRS-TV1JD000J	2125 0 OHM 5% 1/10W SMD	S AA	AA
J 0126	VRS-TV1JD000J	2125 0 OHM 5% 1/10W SMD	S AA	AA
J 0218	VRS-TV1JD000J	2125 0 OHM 5% 1/10W SMD	S AA	AA
J 0219	VRS-TV1JD000J	2125 0 OHM 5% 1/10W SMD	S AA	AA
J 0220	VRS-TV1JD000J	2125 0 OHM 5% 1/10W SMD	S AA	AA
J 0240	VRS-TV1JD000J	2125 0 OHM 5% 1/10W SMD	S AA	AA
J 0248	VRD-RA2HD121J	RES 120 OHM 5% 1/2W	S AA	AA
J 0279	VRS-TV1JD000J	2125 0 OHM 5% 1/10W SMD	S AA	AA

REF No.	PARTS	DESCRIPTION	* SN CODE	EX CODE
J 0281	VRS-TV1JD000J	2125 0 OHM 5% 1/10W SMD	S AA	AA
J 0283	VRS-TV1JD000J	2125 0 OHM 5% 1/10W SMD	S AA	AA
J 0286	VRS-TV1JD000J	2125 0 OHM 5% 1/10W SMD	S AA	AA
J 0289	VRS-TV1JD000J	2125 0 OHM 5% 1/10W SMD	S AA	AA
J 0294	VRS-TV1JD000J	2125 0 OHM 5% 1/10W SMD	S AA	AA
J 0301	QJAKJ0101SEZZ	MINIATURE PHONE JACK MORNING STAR	S AA	AD
J 0302	VRS-TV1JD000J	2125 0 OHM 5% 1/10W SMD	S AA	AA
J 0310	VRS-TV1JD000J	2125 0 OHM 5% 1/10W SMD	S AA	AA
J 0313	VRS-TV1JD000J	2125 0 OHM 5% 1/10W SMD	S AA	AA
J 0335	VRS-TV1JD000J	2125 0 OHM 5% 1/10W SMD	S AA	AA
J 0336	VRS-TV1JD000J	2125 0 OHM 5% 1/10W SMD	S AA	AA
J 0338	VRS-TV1JD000J	2125 0 OHM 5% 1/10W SMD	S AA	AA
J 0339	VRS-TV1JD000J	2125 0 OHM 5% 1/10W SMD	S AA	AA
J 0341	VRS-TV1JD000J	2125 0 OHM 5% 1/10W SMD	S AA	AA
J 0342	VRS-TV1JD000J	2125 0 OHM 5% 1/10W SMD	S AA	AA
J 0345	VRS-TV1JD000J	2125 0 OHM 5% 1/10W SMD	S AA	AA
J 0355	VRS-TV1JD000J	2125 0 OHM 5% 1/10W SMD	S AA	AA
J 0356	VRS-TV1JD000J	2125 0 OHM 5% 1/10W SMD	S AA	AA
J 0360	VRS-TV1JD000J	2125 0 OHM 5% 1/10W SMD	S AA	AA
J 0361	VRS-TV1JD000J	2125 0 OHM 5% 1/10W SMD	S AA	AA
J 0365	VRS-TV1JD000J	2125 0 OHM 5% 1/10W SMD	S AA	AA
J 0369	VRS-TV1JD000J	2125 0 OHM 5% 1/10W SMD	S AA	AA
J 0370	VRS-TV1JD000J	2125 0 OHM 5% 1/10W SMD	S AA	AA
J 0371	VRS-TV1JD000J	2125 0 OHM 5% 1/10W SMD	S AA	AA
J 0372	VRS-TV1JD000J	2125 0 OHM 5% 1/10W SMD	S AA	AA
J 0701	VCKYTY1HF104Z	CERAM C 100NF 50V 2125SMD	S AA	AA
JF 0003	VRS-TV1JD000J	2125 0 OHM 5% 1/10W SMD	S AA	AA
JF 0011	VRS-TV1JD000J	2125 0 OHM 5% 1/10W SMD	S AA	AA
JF 0012	VRS-TV1JD000J	2125 0 OHM 5% 1/10W SMD	S AA	AA
JF 0020	VRS-TV1JD000J	2125 0 OHM 5% 1/10W SMD	S AA	AA
JF 0022	VRS-TV1JD000J	2125 0 OHM 5% 1/10W SMD	S AA	AA
JF 0039	VRS-TV1JD000J	2125 0 OHM 5% 1/10W SMD	S AA	AA
JF 0041	VRS-TV1JD000J	2125 0 OHM 5% 1/10W SMD	S AA	AA
JF 0060	VRS-TV1JD000J	2125 0 OHM 5% 1/10W SMD	S AA	AA
JF 0075	VRS-TV1JD000J	2125 0 OHM 5% 1/10W SMD	S AA	AA
JF 0076	VRS-TV1JD000J	2125 0 OHM 5% 1/10W SMD	S AA	AA
JF 0077	VRS-TV1JD000J	2125 0 OHM 5% 1/10W SMD	S AA	AA
JF 1002	VRS-TV1JD000J	2125 0 OHM 5% 1/10W SMD	S AA	AA
JF 1003	VRS-TV1JD000J	2125 0 OHM 5% 1/10W SMD	S AA	AA
JF 1004	VRS-TV1JD000J	2125 0 OHM 5% 1/10W SMD	S AA	AA
JL 0012	QCWN-2736BMZZ	WIRE 1 WAY	S AA	AF
LP 0701	RLAMP0001BMZZ	NEON TYPE 4/30HB NEOTRONIC	S AB	AC
M 1000	RRMCU0205BMZZ	R/C RECEIVER TSOP2838 TFK	S AB	AF
△ S 0701	QSW-P0600BMZZ	SWITCH S40 3110432713 GDE	S AF	AL
S 0702	QSW-K0079GEZZ	TACTILE SWITCH	S AA	AA
S 0703	QSW-K0079GEZZ	TACTILE SWITCH	S AA	AA
S 0704	QSW-K0079GEZZ	TACTILE SWITCH	S AA	AA
S 0705	QSW-K0079GEZZ	TACTILE SWITCH	S AA	AA
T 0702	RH-SX0003BMZZ	TRIAC BT134W-600 PHILIPS	S AA	AE
	QCWN-2836BMZZ	WIRE (H) 20" 21"	S AA	AD
	QFSDH1001BMZZ	FUSE HOLD.EYF52BC=PANASON	S AA	AA
	QFSDH1002BMZZ	FUSE HOLD.EYF52BC=PANASON	S AA	AA
IC 1002	QSOCZ0115SC32	SOCKET IC 32 PIN	S AA	AB
PWB-B CRT UNIT				
INTEGRATED CIRCUITS				
IC 1801	RH-IX1833BMZZ	IC TDA6109 VIDEO AMPLIFIER 100Hz	S AF	AR
TRANSISTORS				
Q 0901	VS2SC2412KQ-1	TRT 2SC2412 ROHM	S AA	AA
Q 0902	VS2SC2412KQ-1	TRT 2SC2412 ROHM	S AA	AA
Q 0903	VS2SA1037KQ-1	TRT BC807 SMD	S AA	AA
Q 0904	VS2SC2412KQ-1	TRT 2SC2412 ROHM	S AA	AA
Q 0905	VS2SC2412KQ-1	TRT 2SC2412 ROHM	S AA	AA
Q 0906	VS2SA1037KQ-1	TRT BC807 SMD	S AA	AA
Q 0907	VS2SC2412KQ-1	TRT 2SC2412 ROHM	S AA	AA
Q 0908	VS2SC2412KQ-1	TRT 2SC2412 ROHM	S AA	AA
Q 0909	VS2SA1037KQ-1	TRT BC807 SMD	S AA	AA
Q 0912	RH-TX0217BMZZ	TRT BC337 PHILIPS	S AA	AB
Q 0913	VS2SA1037KQ-1	TRT BC807 SMD	S AA	AA
DIODES				
D 1804	RH-DX0551BMZZ	DIODE LL4148 TFK SMD	S AA	AA
D 1805	RH-EX0554BMZZ	ZENER DIODE TZMC12 TFK SMD	S AA	AA

REF No.	PARTS	DESCRIPTION	* SN CODE	EX CODE
D 1809	RH-DX0501BMZZ	DIODE 1N4004	S AA	AA
D 1810	RH-EX0546BMZZ	ZENER DIODE TZMC5V6 TFK SMD	S AA	AA
D 1813	RH-DX0505BMZZ	DIODE 1N4935	S AB	AE
D 1814	RH-DX0505BMZZ	DIODE 1N4935	S AB	AE
D 1815	RH-DX0505BMZZ	DIODE 1N4935	S AB	AE
COILS				
L 1801	RCILP0276BMZZ	COIL AR621LY-470K=R TOKO	S AC	AD
L 1802	VP-NM470K2R0N	COIL 47UH SMD 10%	S AA	AC
CAPACITORS				
C 1801	VCKYTV1HF104Z	CERAM C 100NF 50V 2125SMD	S AA	AA
C 1805	VCKYTV1EF224Z	CERAM C 220NF 25V 2125SMD	S AA	AA
C 1806	VCKYTV1HF103Z	CERAM C 10NF 50V 2125SMD	S AA	AA
C 1807	VCEAGA1CW107M	ELEC C 100UF 20% 16V	S AA	AA
C 1811	VCEAGA2EW106M	ELEC C 10UF 20% 250V	S AA	AC
C 1812	VCEAGA2EW105M	ELEC C 1UF 20% 250V	S AA	AB
C 1813	VCKYTV1HF103Z	CERAM C 10NF 50V 2125SMD	S AA	AA
C 1814	VCKYPB3DE47Z	C DE1110-1E4722ZK MURATA	S AA	AC
C 1815	VCKYTV1HF473Z	CERAM C 47NF 50V 2125SMD	S AA	AA
C 1820	VCCCTV1HH100D	CERAM C 10PF 50V 2125SMD	S AA	AA
C 1821	VCCCTV1HH100D	CERAM C 10PF 50V 2125SMD	S AA	AA
C 1822	VCCCTV1HH100D	CERAM C 10PF 50V 2125SMD	S AA	AA
C 1823	VCEAGA1CW226M	ELEC C 22UF 20% 16V	S AA	AA
C 1824	VCFYAA2EA333K	POL FILM C 33NF 10% 250V	S AC	AE
RESISTORS				
R 1801	VRD-RA2BE221J	RES 220 OHM 5% 1/8W	S AA	AA
R 1802	VRS-TV1JD391J	2125 390 OHM 5% 1/10W SMD	S AA	AA
R 1803	VRS-TV1JD750J	2125 75 OHM 5% 1/10W SMD	S AA	AA
R 1804	VRS-TV1JD101J	2125 100 OHM 5% 1/10W SMD	S AA	AA
R 1805	VRS-TV1JD102J	2125 1KOHM 5% 1/10W SMD	S AA	AA
R 1806	VRS-TV1JD181J	2125 180 OHM 5% 1/10W SMD	S AA	AA
R 1807	VRS-TV1JD391J	2125 390 OHM 5% 1/10W SMD	S AA	AA
R 1808	VRS-TV1JD750J	2125 75 OHM 5% 1/10W SMD	S AA	AA
R 1809	VRS-TV1JD101J	2125 100 OHM 5% 1/10W SMD	S AA	AA
R 1810	VRS-TV1JD102J	2125 1KOHM 5% 1/10W SMD	S AA	AA
R 1811	VRS-TV1JD181J	2125 180 OHM 5% 1/10W SMD	S AA	AA
R 1812	VRS-TV1JD391J	2125 390 OHM 5% 1/10W SMD	S AA	AA
R 1813	VRS-TV1JD750J	2125 75 OHM 5% 1/10W SMD	S AA	AA
R 1814	VRS-TV1JD101J	2125 100 OHM 5% 1/10W SMD	S AA	AA
R 1815	VRS-TV1JD102J	2125 1KOHM 5% 1/10W SMD	S AA	AA
R 1816	VRS-TV1JD181J	2125 180 OHM 5% 1/10W SMD	S AA	AA
R 1830	VRS-TV1JD472J	2125 4.7KOHM 5% 1/10W SMD	S AA	AA
R 1831	VRD-RA2HD101J	RES 100 OHM 5% 1/2W	S AA	AA
R 1832	VRC-MA2HG681J	SOLID R 680 OHM 5% 1/2W	S AA	AB
R 1833	VRD-RA2HD101J	RES 100 OHM 5% 1/2W	S AA	AA
R 1834	VRC-MA2HG681J	SOLID R 680 OHM 5% 1/2W	S AA	AB
R 1835	VRD-RA2HD101J	RES 100 OHM 5% 1/2W	S AA	AA
R 1836	VRC-MA2HG681J	SOLID R 680 OHM 5% 1/2W	S AA	AB
R 1837	VRS-TV1JD225J	2125 2.2MOHM 5% 1/10W SMD	S AA	AA
R 1839	VRS-TV1JD100J	2125 10 OHM 5% 1/10W SMD	S AA	AA
R 1841	VRS-TQ2BD220J	OX RE 22 OHM 5% 1/8W SMD	S AA	AA
R 1843	VRS-TV1JD102J	2125 1KOHM 5% 1/10W SMD	S AA	AA
R 1844	VRS-TV1JD122J	2125 1.2KOHM 5% 1/10W SMD	S AA	AA
MISCELLANEOUS PARTS				
△	QSOCV0103BMZZ	SOCK HPS1521-014408 HOSHI	S AD	AG
(K)	QPLGN0641CEZZ	PLUG	S AA	AA
JF 0062	VRS-TV1JD102J	2125 1KOHM 5% 1/10W SMD	S AA	AA
VR 1801	RH-VX0037BMZZ	VARIATOR 2322 593 02506 BC 25V	S AA	AC
PWB-C DIGITAL MODULE				
INTEGRATED CIRCUITS				
IC 6001	RH-IX1790BMZZ	IC VPC3230D-BZ MICRONAS	S AV	BG
IC 6002	RH-IX1807BMZZ	CI SAA4956TJ PHILIPS VIDEO MEMORY	S AS	BD
IC 6003	RH-IX1788BMZZ	CI DDP3310B-E4 MICRONAS	S AU	BF
IC 6005	RH-IX1674BMZZ	IC KA431AZ SAMSUNG	S AA	AD
IC 6006	RH-IX1556BMZZ	IC BA10393 SOP8 SMD ROHM	S AC	AD
TRANSISTORS				
Q 6003	RH-TX0108BMZZ	TRT BC635	S AA	AC
Q 6008	VS2SC2412KQ-1	TRT 2SC2412 ROHM	S AA	AA
Q 6021	VS2SC2412KQ-1	TRT 2SC2412 ROHM	S AA	AA

REF No.	PARTS	DESCRIPTION	* SN CODE	EX CODE
Q 6022	VS2SA1037KQ-1	TRT BC807 SMD	S AA	AA
Q 6023	VS2SC2412KQ-1	TRT 2SC2412 ROHM	S AA	AA
Q 6024	VS2SA1037KQ-1	TRT BC807 SMD	S AA	AA
Q 6027	VS2SC2412KQ-1	TRT 2SC2412 ROHM	S AA	AA
DIODES				
D 6001	RH-EX0544BMZZ	ZENER DIODE TZMC4V7 TFK SMD	S AA	AA
D 6002	RH-DX0551BMZZ	DIODE LL4148 TFK SMD	S AA	AA
D 6003	RH-DX0551BMZZ	DIODE LL4148 TFK SMD	S AA	AA
D 6004	RH-EX0544BMZZ	ZENER DIODE TZMC4V7 TFK SMD	S AA	AA
D 6005	RH-DX0551BMZZ	DIODE LL4148 TFK SMD	S AA	AA
D 6006	RH-EX0561BMZZ	ZENER DIODE TZMC24 TFK SMD	S AA	AA
D 6007	RH-DX0551BMZZ	DIODE LL4148 TFK SMD	S AA	AA
D 6008	RH-DX0551BMZZ	DIODE LL4148 TFK SMD	S AA	AA
D 6010	RH-DX0551BMZZ	DIODE LL4148 TFK SMD	S AA	AA
PACKAGED CIRCUITS				
X 1003	RCRSB0236BMZZ	CRYSTAL 5MHZ ACAL	S AB	AG
X 6001	RCRSB0219BMZZ	CRYSTAL 20.25 HMZ	S AG	AH
COILS				
L 6001	VP-NM3R3MR19N	COIL 3.3UH SMD	S AA	AC
L 6002	VP-NM3R3MR19N	COIL 3.3UH SMD	S AA	AC
L 6003	VP-NM3R3MR19N	COIL 3.3UH SMD	S AA	AC
L 6004	VP-NM100KR42N	COIL 10UH SMD	S AA	AC
L 6005	VP-NM1R0MR10N	COIL 1UH SMD	S AB	AB
L 6006	VP-NM3R3MR19N	COIL 3.3UH SMD	S AA	AC
L 6007	VP-NM3R3MR19N	COIL 3.3UH SMD	S AA	AC
L 6008	VP-NM3R3MR19N	COIL 3.3UH SMD	S AA	AC
L 6009	VP-NM3R3MR19N	COIL 3.3UH SMD	S AA	AC
L 6010	VP-NM3R3MR19N	COIL 3.3UH SMD	S AA	AC
L 6012	VP-NM3R3MR19N	COIL 3.3UH SMD	S AA	AC
L 6013	VP-NM3R3MR19N	COIL 3.3UH SMD	S AA	AC
L 6014	VP-NM3R3MR19N	COIL 3.3UH SMD	S AA	AC
L 6015	VP-NM3R3MR19N	COIL 3.3UH SMD	S AA	AC
L 6017	VP-NM3R3MR19N	COIL 3.3UH SMD	S AA	AC
CAPACITORS				
C 6001	VCKYTV1HF683Z	CERAM C 68NF 50V 2125SMD	S AA	AA
C 6002	VCKYTV1HB152K	CERAM C 1.5NF 50V 2125SMD	S AA	AA
C 6004	VCKYTV1HF683Z	CERAM C 68NF 50V 2125SMD	S AA	AA
C 6005	VCKYTV1EF224Z	CERAM C 220NF 25V 2125SMD	S AA	AA
C 6006	VCKYTV1HF473Z	CERAM C 47NF 50V 2125SMD	S AA	AA
C 6007	VCKYTV1HB152K	CERAM C 1.5NF 50V 2125SMD	S AA	AA
C 6008	VCKYTV1HF104Z	CERAM C 100NF 50V 2125SMD	S AA	AA
C 6010	VCKYTV1HF683Z	CERAM C 68NF 50V 2125SMD	S AA	AA
C 6011	VCKYTV1HF104Z	CERAM C 100NF 50V 2125SMD	S AA	AA
C 6014	VCEAGA1HW335M	ELEC C 3.3UF 20% 50V	S AA	AA
C 6015	VCKYTV1HF104Z	CERAM C 100NF 50V 2125SMD	S AA	AA
C 6016	VCEAGA1HW226M	ELEC C 22UF 20% 50V	S AA	AA
C 6017	VCKYTV1HF223Z	CERAM C 22NF 50V 2125SMD	S AA	AA
C 6018	VCKYTV1HF153Z	CERAM C 15NF 50V 2125SMD	S AA	AA
C 6019	VCKYTV1HF153Z	CERAM C 15NF 50V 2125SMD	S AA	AA
C 6020	VCKYTV1HF153Z	CERAM C 15NF 50V 2125SMD	S AA	AA
C 6021	VCEAGA1HW226M	ELEC C 22UF 20% 50V	S AA	AA
C 6022	VCKYTV1HF223Z	CERAM C 22NF 50V 2125SMD	S AA	AA
C 6023	VCEAGA1HW226M	ELEC C 22UF 20% 50V	S AA	AA
C 6024	VCKYTV1HF104Z	CERAM C 100NF 50V 2125SMD	S AA	AA
C 6025	VCCCTV1HH391J	CERAM C 390PF 50V 2125SMD	S AA	AA
C 6026	VCKYTV1HB152K	CERAM C 1.5NF 50V 2125SMD	S AA	AA
C 6027	VCEAGA1HW476M	ELEC C 47UF 20% 50V	S AA	AA
C 6028	VCKYTV1HF473Z	CERAM C 47NF 50V 2125SMD	S AA	AA
C 6029	VCKYTV1HF103Z	CERAM C 10NF 50V 2125SMD	S AA	AA
C 6030	VCEAGA0JW477M	ELEC C 470UF 20% 6.3V	S AA	AA
C 6031	VCCCTV1HH3R3C	CERAM C 3.3PF 50V 2125SMD	S AA	AA
C 6032	VCCCTV1HH3R3C	CERAM C 3.3PF 50V 2125SMD	S AA	AA
C 6033	VCKYTV1HF103Z	CERAM C 10NF 50V 2125SMD	S AA	AA
C 6034	VCEAGA0JW477M	ELEC C 470UF 20% 6.3V	S AA	AA
C 6035	VCEAGA1HW476M	ELEC C 47UF 20% 50V	S AA	AA
C 6036	VCKYTV1HF473Z	CERAM C 47NF 50V 2125SMD	S AA	AA
C 6037	VCKYTV1HF473Z	CERAM C 47NF 50V 2125SMD	S AA	AA
C 6038	VCCCTV1HH391J	CERAM C 390PF 50V 2125SMD	S AA	AA
C 6039	VCKYTV1EF334Z	CERAM C 330NF 25V 2125SMD	S AA	AB
C 6040	VCKYTV1EF334Z	CERAM C 330NF 25V 2125SMD	S AA	AB

REF No.	PARTS	DESCRIPTION	* SN CODE	EX CODE
C 6043	VCCCTV1HH151J	CERAM C 150PF 50V 2125SMD	S AA	AA
C 6046	VCKYTV1EF334Z	CERAM C 330NF 25V 2125SMD	S AA	AB
C 6047	VCKYTV1EF334Z	CERAM C 330NF 25V 2125SMD	S AA	AB
C 6050	VCCCTV1HH151J	CERAM C 150PF 50V 2125SMD	S AA	AA
C 6051	VCKYTV1HB152K	CERAM C 1.5NF 50V 2125SMD	S AA	AA
C 6052	VCKYTV1EF224Z	CERAM C 220NF 25V 2125SMD	S AA	AA
C 6053	VCKYTV1EF334Z	CERAM C 330NF 25V 2125SMD	S AA	AB
C 6054	VCKYTV1EF334Z	CERAM C 330NF 25V 2125SMD	S AA	AB
C 6055	VCCCTV1HH331J	CERAM C 330PF 50V 2125SMD	S AA	AA
C 6056	VCCCTV1HH331J	CERAM C 330PF 50V 2125SMD	S AA	AA
C 6057	VCCCTV1HH151J	CERAM C 150PF 50V 2125SMD	S AA	AA
C 6058	VCCCTV1HH331J	CERAM C 330PF 50V 2125SMD	S AA	AA
C 6059	VCCCTV1HH331J	CERAM C 330PF 50V 2125SMD	S AA	AA
C 6060	VCKYTV1HB102K	CERAM C 1NF 50V 2125SMD	S AA	AA
C 6061	VCKYTV1EF334Z	CERAM C 330NF 25V 2125SMD	S AA	AB
C 6062	VCKYTV1EF334Z	CERAM C 330NF 25V 2125SMD	S AA	AB
C 6063	VCCCTV1HH60J	CERAM C 56PF 50V 2125SMD	S AA	AA
C 6065	VCEAGA1HW106M	ELEC C 10UF 20% 50V	S AA	AA
C 6066	VCKYTV1HF104Z	CERAM C 100NF 50V 2125SMD	S AA	AA
C 6067	VCKYTV1HF104Z	CERAM C 100NF 50V 2125SMD	S AA	AA
C 6068	VCKYTV1HB102K	CERAM C 1NF 50V 2125SMD	S AA	AA
C 6069	VCEAGA1HW106M	ELEC C 10UF 20% 50V	S AA	AA
C 6070	VCCCTV1HH151J	CERAM C 150PF 50V 2125SMD	S AA	AA
C 6072	VCCCTV1HH330J	CERAM C 33PF 50V 2125SMD	S AA	AA
C 6073	VCCCTV1HH330J	CERAM C 33PF 50V 2125SMD	S AA	AA
C 6074	VCKYTV1HF104Z	CERAM C 100NF 50V 2125SMD	S AA	AA
C 6078	VCKYTV1CF105Z	CERAM C 1UF 16V 2125SMD	S AA	AA
C 6079	RC-FZ4223BMNJ	POL FILM C 22nF 50V 5% ECQ-B PANASONIC	S AA	AA
C 6081	VCCCTV1HH221J	CERAM C 220PF 50V 2125SMD	S AA	AA
C 6084	VCKYTV1HB102K	CERAM C 1NF 50V 2125SMD	S AA	AA
C 6085	VCCCTV1HH330J	CERAM C 33PF 50V 2125SMD	S AA	AA
C 6109	VCKYTV1CF105Z	CERAM C 1UF 16V 2125SMD	S AA	AA
C 6110	VCKYTV1HB393K	CERAM C 39NF 50V 2125SMD	S AA	AA
C 6205	VCCCTV1HH101J	CERAM C 100PF 50V 2125SMD	S AA	AA
RESISTORS				
R 6001	VRS-TV1JD750J	2125 75 OHM 5% 1/10W SMD	S AA	AA
R 6002	VRS-TV1JD750J	2125 75 OHM 5% 1/10W SMD	S AA	AA
R 6003	VRS-TV1JD750J	2125 75 OHM 5% 1/10W SMD	S AA	AA
R 6004	VRS-TV1JD221J	2125 220 OHM 5% 1/10W SMD	S AA	AA
R 6005	VRS-TV1JD821J	2125 820 OHM 5% 1/10W SMD	S AA	AA
R 6006	VRS-TV1JD821J	2125 820 OHM 5% 1/10W SMD	S AA	AA
R 6007	VRS-TV1JD821J	2125 820 OHM 5% 1/10W SMD	S AA	AA
R 6008	VRS-TV1JD101J	2125 100 OHM 5% 1/10W SMD	S AA	AA
R 6009	VRS-TV1JD101J	2125 100 OHM 5% 1/10W SMD	S AA	AA
R 6010	VRS-TV1JD101J	2125 100 OHM 5% 1/10W SMD	S AA	AA
R 6011	VRS-TV1JD101J	2125 100 OHM 5% 1/10W SMD	S AA	AA
R 6012	VRS-TV1JD101J	2125 100 OHM 5% 1/10W SMD	S AA	AA
R 6013	VRS-TV1JD101J	2125 100 OHM 5% 1/10W SMD	S AA	AA
R 6014	VRS-TV1JD101J	2125 100 OHM 5% 1/10W SMD	S AA	AA
R 6015	VRS-TV1JD101J	2125 100 OHM 5% 1/10W SMD	S AA	AA
R 6016	VRS-TV1JD101J	2125 100 OHM 5% 1/10W SMD	S AA	AA
R 6017	VRS-TV1JD101J	2125 100 OHM 5% 1/10W SMD	S AA	AA
R 6018	VRS-TV1JD101J	2125 100 OHM 5% 1/10W SMD	S AA	AA
R 6019	VRS-TV1JD101J	2125 100 OHM 5% 1/10W SMD	S AA	AA
R 6020	VRS-TV1JD101J	2125 100 OHM 5% 1/10W SMD	S AA	AA
R 6021	VRS-TV1JD101J	2125 100 OHM 5% 1/10W SMD	S AA	AA
R 6022	VRS-TV1JD101J	2125 100 OHM 5% 1/10W SMD	S AA	AA
R 6023	VRS-TV1JD101J	2125 100 OHM 5% 1/10W SMD	S AA	AA
R 6024	VRS-TV1JD101J	2125 100 OHM 5% 1/10W SMD	S AA	AA
R 6025	VRS-TV1JD101J	2125 100 OHM 5% 1/10W SMD	S AA	AA
R 6026	VRS-TV1JD101J	2125 100 OHM 5% 1/10W SMD	S AA	AA
R 6027	VRS-TV1JD101J	2125 100 OHM 5% 1/10W SMD	S AA	AA
R 6028	VRS-TV1JD101J	2125 100 OHM 5% 1/10W SMD	S AA	AA
R 6029	VRS-TV1JD101J	2125 100 OHM 5% 1/10W SMD	S AA	AA
R 6030	VRS-TV1JD101J	2125 100 OHM 5% 1/10W SMD	S AA	AA
R 6031	VRS-TV1JD101J	2125 100 OHM 5% 1/10W SMD	S AA	AA
R 6032	VRS-TV1JD103J	2125 10KOHM 5% 1/10W SMD	S AA	AA
R 6035	VRS-TV1JD102J	2125 1KOHM 5% 1/10W SMD	S AA	AA
R 6036	VRS-TV1JD473J	2125 47KOHM 5% 1/10W SMD	S AA	AA
R 6037	VRS-TV1JD562J	2125 5.6KOHM 5% 1/10W SMD	S AA	AA
R 6038	VRS-TV1JD473J	2125 47KOHM 5% 1/10W SMD	S AA	AA
R 6039	VRS-TV1JD472J	2125 4.7KOHM 5% 1/10W SMD	S AA	AA
R 6040	VRS-TV1JD122J	2125 1.2KOHM 5% 1/10W SMD	S AA	AA

REF No.	PARTS	DESCRIPTION	* SN CODE	EX CODE
R 6041	VRS-TV1JD271J	2125 270 OHM 5% 1/10W SMD	S AA	AA
R 6042	VRS-TV1JD222J	2125 2.2KOHM 5% 1/10W SMD	S AA	AA
R 6043	VRS-TV1JD223J	2125 22KOHM 5% 1/10W SMD	S AA	AA
R 6048	VRS-TV1JD103J	2125 10KOHM 5% 1/10W SMD	S AA	AA
R 6049	VRS-TV1JD102J	2125 1KOHM 5% 1/10W SMD	S AA	AA
R 6050	RR-XZ0204BMZZ	FUS RES 2R2 TAP 5% 12W	S AA	AB
R 6051	VRS-TV1JD271J	2125 270 OHM 5% 1/10W SMD	S AA	AA
R 6052	VRS-TV1JD821J	2125 820 OHM 5% 1/10W SMD	S AA	AA
R 6054	VRS-TV1JD272J	2125 2.7KOHM 5% 1/10W SMD	S AA	AA
R 6068	VRS-TV1JD681J	2125 680 OHM 5% 1/10W SMD	S AA	AA
R 6069	VRS-TV1JD153J	2125 15KOHM 5% 1/10W SMD	S AA	AA
R 6071	VRS-TV1JD750J	2125 75 OHM 5% 1/10W SMD	S AA	AA
R 6072	VRS-TV1JD750J	2125 75 OHM 5% 1/10W SMD	S AA	AA
R 6073	VRS-TV1JD750J	2125 75 OHM 5% 1/10W SMD	S AA	AA
R 6074	VRS-TV1JD750J	2125 75 OHM 5% 1/10W SMD	S AA	AA
R 6075	VRS-TV1JD750J	2125 75 OHM 5% 1/10W SMD	S AA	AA
R 6086	VRS-TV1JD105J	2125 1MOHM 5% 1/10W SMD	S AA	AA
R 6088	VRS-TV1JD103J	2125 10KOHM 5% 1/10W SMD	S AA	AA
R 6089	VRS-TV1JD000J	2125 0 OHM 5% 1/10W SMD	S AA	AA
R 6090	VRS-TV1JD153J	2125 15KOHM 5% 1/10W SMD	S AA	AA
R 6096	VRS-TV1JD221J	2125 220 OHM 5% 1/10W SMD	S AA	AA
R 6097	VRS-TV1JD101J	2125 100 OHM 5% 1/10W SMD	S AA	AA
R 6098	VRS-TV1JD331J	2125 330 OHM 5% 1/10W SMD	S AA	AA
R 6099	VRS-TV1JD680J	2125 68 OHM 5% 1/10W SMD	S AA	AA
R 6100	VRS-TV1JD104J	2125 100KOHM 5% 1/10W SMD	S AA	AA
R 6101	VRS-TV1JD104J	2125 100KOHM 5% 1/10W SMD	S AA	AA
R 6102	VRS-TV1JD334J	2125 330KOHM 5% 1/10W SMD	S AA	AA
R 6103	VRS-TV1JD103J	2125 10KOHM 5% 1/10W SMD	S AA	AA
R 6104	VRS-TV1JD475J	2125 4.7MOHM 5% 1/10W SMD	S AA	AA
R 6105	VRS-TV1JD823J	2125 82KOHM 5% 1/10W SMD	S AA	AA
R 6106	VRS-TV1JD683J	2125 68KOHM 5% 1/10W SMD	S AA	AA
R 6107	VRS-TV1JD564J	2125 560KOHM 5% 1/10W SMD	S AA	AA
R 6130	VRS-TV1JD271J	2125 270 OHM 5% 1/10W SMD	S AA	AA
R 6307	VRS-TV1JD103J	2125 10KOHM 5% 1/10W SMD	S AA	AA
MISCELLANEOUS PARTS				
(KA)	QPLGN0642CEZZ	PLUG	S AA	AB
(RGB)	QPLGN0442CEZZ	PLUG	S AA	AA
(YA)	QPLGN1285CEZZ	PLUG	S AB	AD
(YB)	QPLGN1285CEZZ	PLUG	S AB	AD
(YC)	QPLGN1285CEZZ	PLUG	S AB	AD
FB 6205	VRS-TQ2BD000J	3216 0 OHM 5% 1/8W SMD	S AA	AA
FB 6206	VRS-TQ2BD000J	3216 0 OHM 5% 1/8W SMD	S AA	AA
FB 6207	VRS-TQ2BD000J	3216 0 OHM 5% 1/8W SMD	S AA	AA
FB 6208	VRS-TQ2BD000J	3216 0 OHM 5% 1/8W SMD	S AA	AA
FB 6210	VRS-TQ2BD000J	3216 0 OHM 5% 1/8W SMD	S AA	AA
FB 6211	VRS-TQ2BD000J	3216 0 OHM 5% 1/8W SMD	S AA	AA
FB 6212	VRS-TQ2BD000J	3216 0 OHM 5% 1/8W SMD	S AA	AA
JF 0004	VRS-TV1JD000J	2125 0 OHM 5% 1/10W SMD	S AA	AA
JF 0004	VRS-TV1JD000J	2125 0 OHM 5% 1/10W SMD	S AA	AA
PWB-D PFC MODULE				
INTEGRATED CIRCUIT				
IC 1701	RH-IX1801BMZZ	IC L6561D ST	S AC	AH
TRANSISTOR				
Q 1701	RH-TX0231BMZZ	TRT 2SK2662 TOSHIBA	S AB	AG
TRANSFORMER				
T 1701	RTRNZ0586BMZZ	BOOST INDUCTOR PFC HR 6R4 15020-00	S AD	AM
CAPACITORS				
C 1701	RC-FZ0221BMZZ	C 330NF 630V B32653-A6334-J EPCOS	S AA	AD
C 1702	RC-FZ4103BMNJ	POL FILM C 10nF 50V 5% ECQ-B PANASONIC	S AA	AA
C 1703	VCEAGA1EW226M	ELEC C 22UF 20% 25V	S AA	AA
C 1704	RC-KZ0035CEZZ	CERAM C 220PF 2KV	S AA	AC
C 1705	VCKYTV1CF105Z	CERAM C 1UF 16V 2125SMD	S AA	AA
C 1706	VCKYTV1HB103K	CERAM C 10NF 50V 2125SMD	S AA	AA
C 1707	RC-FZ0221BMZZ	C 330NF 630V B32653-A6334-J EPCOS	S AA	AD
RESISTORS				
R 1701	VRS-TQ2BD564J	RE OX 560KOHM 5% 1/8W SMD	S AA	AA
R 1702	VRS-TQ2BD564J	RE OX 560KOHM 5% 1/8W SMD	S AA	AA
R 1703	VRS-TQ2BD564J	RE OX 560KOHM 5% 1/8W SMD	S AA	AA

REF No.	PARTS	DESCRIPTION	* SN CODE	EX CODE
R 1704	VRS-TQ2BD564J	RE OX 560KOHM 5% 1/8W SMD	S AA	AA
R 1705	VRS-TQ2BD564J	RE OX 560KOHM 5% 1/8W SMD	S AA	AA
R 1706	VRS-TQ2BD564J	RE OX 560KOHM 5% 1/8W SMD	S AA	AA
R 1707	VRS-TV1JD101J	2125 100 OHM 5% 1/10W SMD	S AA	AA
R 1708	VRS-TV1JD683J	2125 68KOHM 5% 1/10W SMD	S AA	AA
R 1709	VRD-RA2BE100J	RES 10 OHM 5% 1/8W	S AA	AA
R 1710	VRN-VV3ABR47J	MET FILM R. 47 OHM 5% 1W	S AA	AA
R 1711	VRS-TV1JD103J	2125 10KOHM 5% 1/10W SMD	S AA	AA
R 1712	VRS-TV1JD622F	2125 6.2KOHM 1% 1/10W SMD	S AA	AA
R 1713	VRS-TQ2BD334F	OX RE 330KOHM 1% 1/8W SMD	S AA	AA
R 1714	VRS-TQ2BD334F	OX RE 330KOHM 1% 1/8W SMD	S AA	AA
R 1715	VRS-TQ2BD334F	OX RE 330KOHM 1% 1/8W SMD	S AA	AA
DIODES				
D 1701	RH-DX0551BMZZ	DIODE LL4148 TFK SMD	S AA	AA
D 1702	RH-EX0558BMZZ	ZENER DIODE TZMC18 TFK SMD	S AA	AA
D 1703	RH-DX0618BMZZ	DIODE BYV28-600 VISHAY PREFOR 17.5MM	S AA	AE
MISCELLANEOUS PARTS				
(PWA)	QCNCM0672FCZZ	CONN B2P3-VH JST	S AA	AB
FB 1701	RBLN-0080CEZZ	BALUNE	S AA	AE
L 0006	QTIPM0017CEFM	TIP	S AA	AA
MISCELLANEOUS PARTS				
	PMLT-1038BM00	SPACER 25X20X15 MM	S AA	AC
△	QCQW-2745BMZZ	MAT WIRE OREGA 100463.20	S AA	AH
△	QCQW-2746BMZZ	FOCO WIRE OREGA 704030.54	S AA	AC
	QCQW-2747BMZZ	G2 WIRE OREGA 578129.50	S AA	AD
	QCQW-2782BMZZ	WIRE 3 WAYS (RGB)	S AA	AK
(FH)	QCQW-2841BMZZ	WIRE 4 WAYS FH DA100 4:3	S AA	AG
(K)	QCQW-2773BMZZ	MANGUERA (K)	S AA	AH
(PW)	QCQW-2868BMZZ	POWER SUPPLIER WIRE PFC PWA	S AB	AF
FB 0001	RCORF0002BMZZ	FERRITE CORE TFC-16816EX	S AF	AK
L 0006	QCQW-2861BMZZ	WIRE WROUND DOUBLE AISOLATION	S AA	AD
	QCQW-2861BMZZ	CON W (4)WAYS	S AA	AH
	PCAPH1500BMN1	SWITCH COVER	S AA	AB
	RCORF2064XHZZ	FERRIT TRA31	S AA	AD
	UBATU0247AJZZ	BATTERY R6(X2)	S AE	AH
△	QACCZ2100BMSA	AC CORD	S AH	AR
	RRMCG1071BMSA	R/C CA-10 HOSIDEN	S AS	AW
	VSP1206PB617A	SPAEAKER 7 OHM 12x6CM SEA TRADE ELECTRON	S AE	AN
OWNERS MANUALS				
	TINS-6974BMN1	OWNERS MANUAL 70GS64SDE	S AB	AG
	TINS-6977BMN0	OWNERS MANUAL 70GS64SIT	S AD	AM
CABINET PARTS				
1	CCABA1310BMV1	CABINET SET+ELEC ASS 70GS64S	S -	-
1.1	GDORF1053BMSC	DOOR	S AA	AD
1.2	PKAL-1083BM00	DOOR LATCH	S AC	AF
1.3	HBDGB3013MESB	BADGE	S AC	AH
1.4	HDECQ0041BMSA	LED DECORATION(70ES-03S)	S AA	AB
1.5	HDECQ0042BMSA	R/C DECORATION(70ES-03S)	S AA	AC
1.6	JBTN-1053BMSC	UP/DOWN BUTTON	S AA	AD
1.7	JBTN-1052BMSC	POWER BUTTON	S AA	AD
△ 2	GCABB1083BMKA	CAB-B(70ES-04S)	S AA	BA
3	XTASB40P20000	REAR CABINET SCREWS	S AA	AA

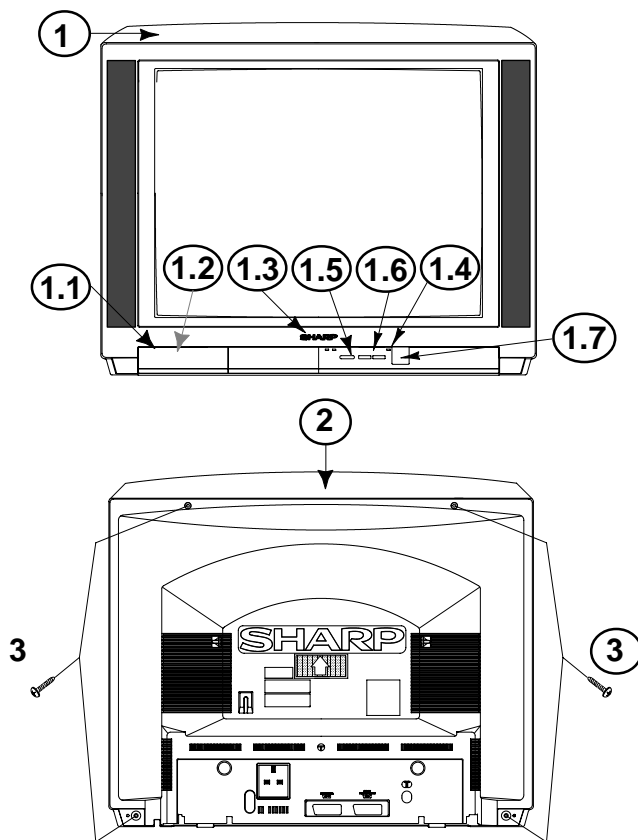

ALTERNATIVE PARTS

1. CRT THOMSON: VB66EHJ4312*N or VB66EHJ1312*N.

The original Philips CRT (VB66EAK0714*N) may be replaced by VB66EHJ4312*N or VB66EHJ1312*N depending on the stock of CRTs. Both Thomson CRTs are completely interchangeable (VB66EHJ4312*N has got a glass transmission (GT) of 48%, while VB66EHJ1312*N has got a GT of 52%).

In case you receive any TV with one of the above Thomson CRTs it may perfectly be serviced thru Schematic Diagrams included in this Service Manual, the differences (in most cases of value) are below detailed.

PHILIPS PARTS LISTING

This parts listing only includes those which differ from the used for the alternative Thomson CRTs.

REPLACEMENT PARTS

Replacement parts which have special safety characteristics are identified in this manual. Electrical components having such features are identified by Δ in the Replacement Part List.

The use of a substitute replacement part which does not have the same safety characteristics as the factory recommended is not permitted.

Replacement parts not shown in this service manual may create shock fire, or other hazards.

HOW TO ORDER REPLACEMENT PARTS

To have your order completed promptly and correctly please supply the following information.

- | | |
|-----------------|----------------|
| 1. MODEL NUMBER | 2. REF. NO. |
| 3. PART NO. | 4. DESCRIPTION |
| 5. CODE | 6. QUANTITY |

MARK *: SPARE PARTS DELIVERY SECTION

REF No.	PARTS	DESCRIPTION	*	SN CODE	EX CODE
PHILIPS PICTURE TUBE					
Δ	VB66EAK0714*N	28" A66EAK071X44 100HZ PHIL.BLACK 44% GT	S	CQ	CU
PWB-A MOTHER UNIT					
INTEGRATED CIRCUITS					
IC 1002	CH-IX1841CJS2	EPROM SET 4M 3V FLASH (S3-00x24 Soft. Vers. or next)	S	AM	AY
IC 1003	RH-IX1603BMZZ	NVM X24645S8 XICOR SMD (70GS64S9.IIC Version)	S	AS	AV
CAPACITORS					
C 0504	RC-FZ4684BMNJ	POL FILM C 680nF 50V 5% ECQ-V PANASONIC	S	AA	AC
C 0524	RC-FZ4104BMNJ	POL FILM C 100nF 50V 5% ECQ-V PANASONIC	S	AA	AB
C 0540	VCKYTV1HF104Z	CERAM C 100NF 50V 2125SMD	S	AA	AA
C 0610	RC-FZ0159BMZZ	C B32632 15NF 630V SIEMENS	S	AC	AE
C 0713	RC-FZ4683BMNJ	POL FILM C 68nF 50V 5% ECQ-B PANASONIC	S	AA	AB
RESISTORS					
R 0501	VRD-RA2HD151J	RES 150 OHM 5% 1/2W	S	AA	AA
R 0536	VRS-VV3DB102J	MET OX RES 1KOHM 5% 2W	S	AA	AA
R 0536A	-	Not used for Philips CRT	-	-	-
R 0730	VRS-VV3AB820J	MET OX RES 82 OHM 5% 1W	S	AA	AA
PWB-B CRT UNIT					
COILS					
L 1801	RCILP0276BMZZ	COIL AR621LY-470K=R TOKO	S	AC	AD
MISCELLANEOUS PARTS					
(FH)	QCWN-2841BMZZ	WIRE 4 WAYS FH DA100 4:3	S	AA	AG

THOMSON PARTS LISTING

This parts listing only includes those which differ from the used for the Philips CRT.

REPLACEMENT PARTS

Replacement parts which have special safety characteristics are identified in this manual. Electrical components having such features are identified by Δ in the Replacement Part List.

The use of a substitute replacement part which does not have the same safety characteristics as the factory recommended is not permitted.

Replacement parts not shown in this service manual may create shock fire, or other hazards.

HOW TO ORDER REPLACEMENT PARTS

To have your order completed promptly and correctly please supply the following information.

- | | |
|-----------------|----------------|
| 1. MODEL NUMBER | 2. REF. NO. |
| 3. PART NO. | 4. DESCRIPTION |
| 5. CODE | 6. QUANTITY |

MARK *: SPARE PARTS DELIVERY SECTION

REF No.	PARTS	DESCRIPTION	*	SN CODE	EX CODE
ALTERNATIVE THOMSON PICTURE TUBES					
Δ	VB66EHJ4312*N	TRC 28" 100HZ IRON THOMSON	S	CF	CR
Δ	VB66EHJ1312*N	28" 100Hz THOMSON A66EHJ13x12 GT52%	S	BW	CQ
PWB-A MOTHER UNIT					
INTEGRATED CIRCUITS					
IC 1002	CH-IX1841CJS2	EPROM SET 4M 3V FLASH (S3-00x24 Soft. Vers. or next)	S	AM	AY
IC 1003	RH-IX1603BMZZ	NVM X24645S8 XICOR SMD (70GS64S7.IIC Version)	S	AS	AV
CAPACITORS					
C 0504	RC-FZ4104BMNJ	POL FILM C 100nF 50V 5% ECQ-V PANASONIC	S	AA	AB
C 0524	RC-FZ4683BMNJ	POL FILM C 68nF 50V 5% ECQ-B PANASONIC	S	AA	AB
C 0540	VCKYTV1HF473Z	CERAM C 47NF 50V 2125SMD	S	AA	AA
C 0610	RC-FZ0203BMZZ	C PP 18NF 630V 2222375 14183 BC	S	AA	AD
C 0713	RC-FZ4104BMNJ	POL FILM C 100nF 50V 5% ECQ-V PANASONIC	S	AA	AB
RESISTORS					
R 0501	VRD-RA2HD101J	RES 100 OHM 5% 1/2W	S	AA	AA
R 0536	VRW-VV3HB561J	WOUND RES 560 OHM 5% 5W	S	AA	AA
R 0536A	VT-UL0400T015	VINYL TUBE (UL)	S	--	--
R 0730	VRS-VV3DB151J	MET OX RES 150 OHM 5% 2W	S	AA	AA
PWB-B CRT UNIT					
COILS					
L 1801	RCILP0275BMZZ	COIL	S	AA	AD
MISCELLANEOUS PARTS					
(FH)	QCWN-2860BMZZ	WIRE 4 WAYS (FH) DA-100 4:3 VIDEOCOLOR	S	AB	AF

NOTES:

Fig. 14: How to assemble R536A (Vinyl tube for R536).

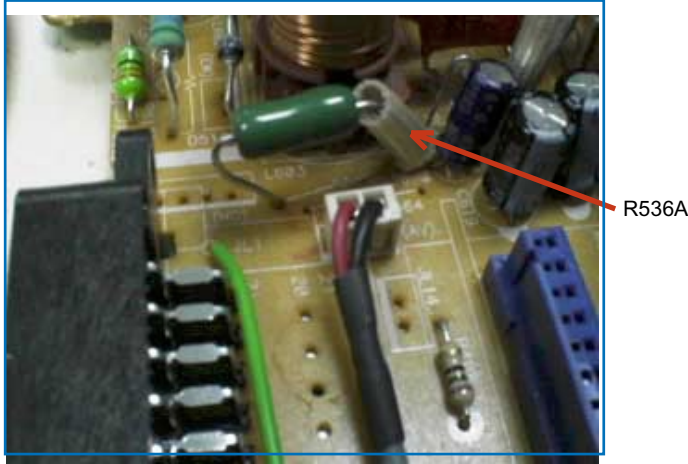
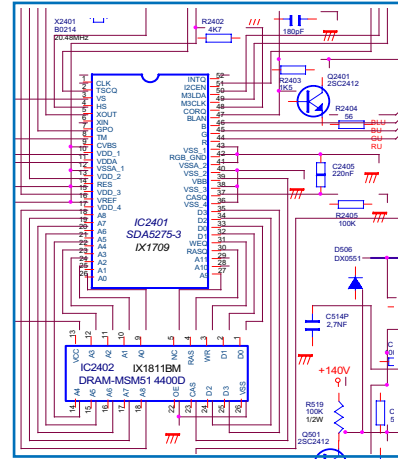

Fig. 15: IC2401-IC2402 configuration.



Taken from 70GF66E SM.

2. IC2401 (MEGATEXT).

The original IC2401 is RH-IX1673BMZZ (SDA5273-2). It has been temporarily used the alternative RH-IX1709BMZZ (SDA5275-3). Please Note that the most important change is that when the alternative one is used, it must be added IC2402. See Fig. 15, in order to know how both ICs are implemented.

SDA5273 PARTS LISTING

This parts listing only includes those which differ from the used for the alternative IC2401 (SDA5275-3).

REPLACEMENT PARTS

Replacement parts which have special safety characteristics are identified in this manual. Electrical components having such features are identified by Δ in the Replacement Part List. The use of a substitute replacement part which does not have the same safety characteristics as the factory recommended is not permitted. Replacement parts not shown in this service manual may create shock fire, or other hazards.

HOW TO ORDER REPLACEMENT PARTS

To have your order completed promptly and correctly please supply the following information.

- 1. MODEL NUMBER
- 2. REF. NO.
- 3. PART NO.
- 4. DESCRIPTION
- 5. CODE
- 6. QUANTITY

MARK *: SPARE PARTS DELIVERY SECTION

REF No.	PARTS	DESCRIPTION	* SN CODE	EX CODE
PWB-A MOTHER UNIT (PHILIPS CRT, VB66EAK0714*N)				
INTEGRATED CIRCUITS				
IC 1002	CH-IX1841CJS2	EPROM SET 4M 3V FLASH (S3-00x24 Soft. Vers. or next)	S AM	AY
IC 1003	RH-IX1603BMZZ	NVM X24645S8 XICOR SMD (70GS64S9.IIC Version)	S AS	AV
IC 2401	RH-IX1673BMZZ	IC SDA5273-2 SIEMENS	S AT	BE
IC 2402	-	Not used for SDA5273-2	- -	-
PWB-A MOTHER UNIT (THOMSON CRTs, VB66EHJ4312*N or VB66EHJ1312*N)				
INTEGRATED CIRCUITS				
IC 1002	CH-IX1841CJS2	EPROM SET 4M 3V FLASH (S3-00x24 Soft. Vers. or next)	S AM	AY
IC 1003	RH-IX1603BMZZ	NVM X24645S8 XICOR SMD (70GS64S9.IIC Version)	S AS	AV
IC 2401	RH-IX1673BMZZ	IC SDA5273-2 SIEMENS	S AT	BE
IC 2402	-	Not used for SDA5273-2	- -	-

SDA5275 PARTS LISTING

This parts listing only includes those which differ from the used for the original IC2401 (SDA5273-2).

REPLACEMENT PARTS

Replacement parts which have special safety characteristics are identified in this manual. Electrical components having such features are identified by Δ in the Replacement Part List. The use of a substitute replacement part which does not have the same safety characteristics as the factory recommended is not permitted. Replacement parts not shown in this service manual may create shock fire, or other hazards.

HOW TO ORDER REPLACEMENT PARTS

To have your order completed promptly and correctly please supply the following information.

- 1. MODEL NUMBER
- 2. REF. NO.
- 3. PART NO.
- 4. DESCRIPTION
- 5. CODE
- 6. QUANTITY

MARK *: SPARE PARTS DELIVERY SECTION

REF No.	PARTS	DESCRIPTION	* SN CODE	EX CODE
PWB-A MOTHER UNIT (PHILIPS CRT, VB66EAK0714*N)				
INTEGRATED CIRCUITS				
IC 1002	CH-IX1841CJS2	EPROM SET 4M 3V FLASH (S3-01x05 Soft. Vers. or next)	S AM	AY
IC 1003	RH-IX1603BMZZ	NVM X24645S8 XICOR SMD (70GS64S5.IIC Version)	S AS	AV
IC 2401	RH-IX1709BMZZ	IC SDA5275-3M3TMT NIVEL2,5	S AT	BD
IC 2402	RH-IX1811BMZZ	IC DRAM MSM514400D-60TS-K OKI	S AG	AS
PWB-A MOTHER UNIT (THOMSON CRTs, VB66EHJ4312*N or VB66EHJ1312*N)				
INTEGRATED CIRCUITS				
IC 1002	CH-IX1841CJS2	EPROM SET 4M 3V FLASH (S3-01x05 Soft. Vers. or next)	S AM	AY
IC 1003	RH-IX1603BMZZ	NVM X24645S8 XICOR SMD (70GS64S8.IIC Version)	S AS	AV
IC 2401	RH-IX1709BMZZ	IC SDA5275-3M3TMT NIVEL2,5	S AT	BD
IC 2402	RH-IX1811BMZZ	IC DRAM MSM514400D-60TS-K OKI	S AG	AS